

# Grottime®

INFA GROUP

## ELARA/BONNIE

30234/30235

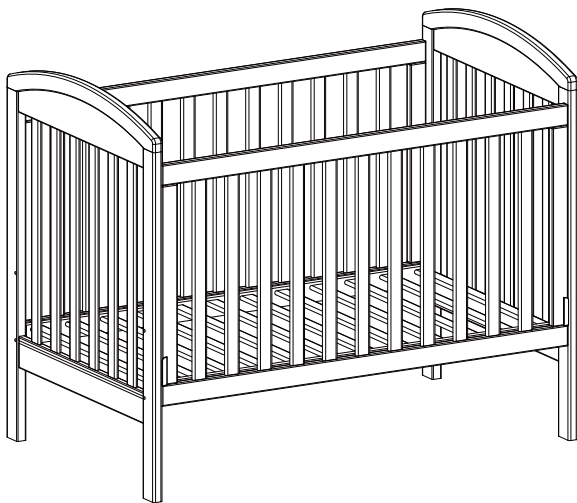

Two adults are required to assemble this cot



Follow all manufacturer's assembly instructions carefully to ensure the safety features of the cot are not compromised

### Grottime

110-114 Old Bathurst Rd,  
Emu Plains, NSW 2750

P.O. Box 487, Emu Plains,  
NSW 2750

### Customer Care

**Email:** [customercare@infa.com.au](mailto:customercare@infa.com.au)

AUSTRALIA  
1300 92 4632  
[www.grottime.com.au](http://www.grottime.com.au)

NEW ZEALAND  
067 590 870  
[www.grottime.co.nz](http://www.grottime.co.nz)

ISSUE B

**KEEP BOOKLET FOR FUTURE REFERENCE**

## **SAFETY INSTRUCTIONS:**

Before using this product, read these instructions in their entirety, for assistance contact Grottime customer care:

AU: 1300 92 4632

NZ: 067 590 870

NOTE: The illustrations displayed throughout this booklet are for demonstration only, product specifications are subject to change without notice. Assemble product according to manufacturers instructions.

## **CARE AND MAINTENANCE**

Check your cot regularly. Re-tighten all bolts. For customers care contact Grottime Australia on 1300 92 4632; or New Zealand on 067 590 870

Do not use abrasive or corrosive agents, lint free cloth and then wipe with a dry cloth.

## **RECOMMENDED MATTRESS SIZE**

This cot has been manufactured for use with a mattress which measures 690mm wide by 1300mm long and 130mm in thickness. The width and length are specified because it is important that the gaps do not exceed 40mm when the mattress is pushed to one side or end, and 20mm when the mattress is centred in the cot. The thickness of the mattress has been specified to ensure that the depth of cot is greater than 500mm with the mattress base in the lower position to minimise the risk of a child climbing or falling out of the cot.

## **STORAGE:**

To store your Cot (30234/30235), please reverse assembly steps. Ensure all components are kept together along with Instruction manual for future use.

**KEEP BOOKLET FOR FUTURE REFERENCE  
READ ALL INSTRUCTIONS CAREFULLY BEFORE USE OF THIS  
COT. ALWAYS FOLLOW THE INSTRUCTIONS. THE CORRECT USE AND  
MAINTENANCE OF THIS PRODUCT IS ESSENTIAL.**

**THIS PRODUCT IS NOT INTENDED FOR COMMERCIAL USE.**



Carefully remove all packaging material and dispose of it according to grade. Be careful not to throw away any components by mistake. After use, dispose of the product in an environmentally friendly manner at your local recycling centre

## HARDWARE INVENTORY

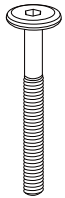

x8

**A** 65mm Bolts

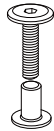

x4

**B** 16mm Bolts & 14mm Cap Nuts



x4

**C** 20 mm Barrel Nut



x4

**D** Guide Pins



x1

**E** Allen Key A

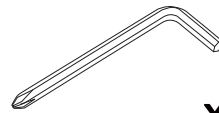

x1

**F** Allen Key /Screw Driver

## PRE-INSTALLED HARDWARE

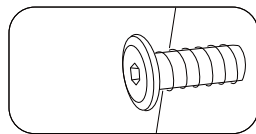

Locking Bolts

## PARTS INVENTORY

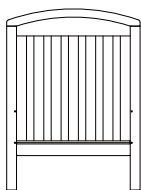

x2

**1** End Panels

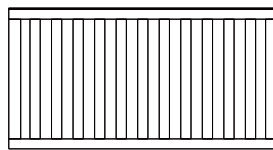

x1

**2** Fixed Sides

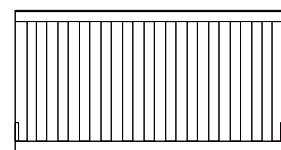

x1

**3** Drop Side

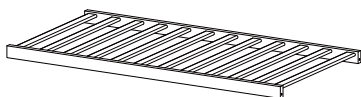

x1

**4** Cot Base



## WARNING



BEFORE ASSEMBLING THE COT, ENSURE YOU HAVE A CLEAR AREA ON CARPET OR A THICK BLANKET OR RUG. NEVER ASSEMBLE ON A HARD SURFACE.

# STEP 1

Assemble fixed sides to end panels using 4 x 65mm bolts.

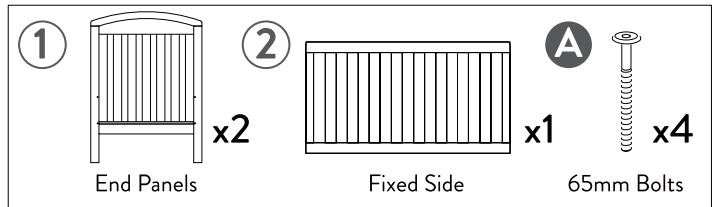

⚠ Do not tighten bolts at this stage

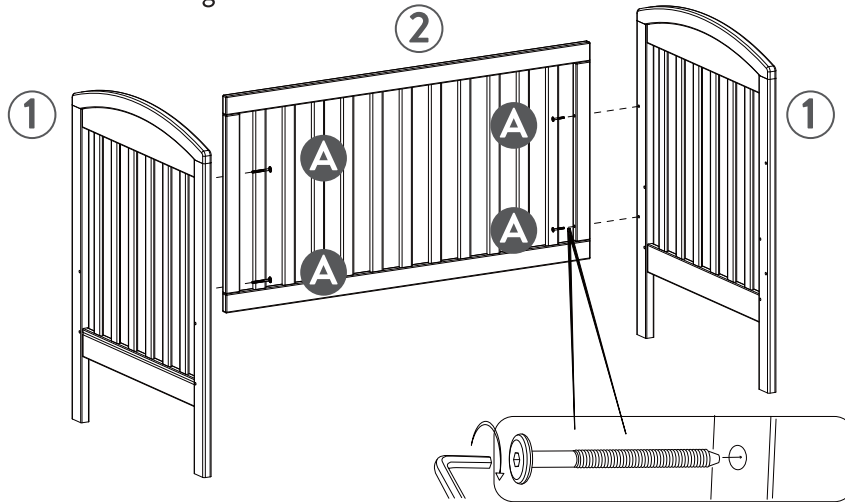

# STEP 2

Assemble Cot Base using 4 x 65mm bolts.

⚠ Do not tighten bolts at this stage

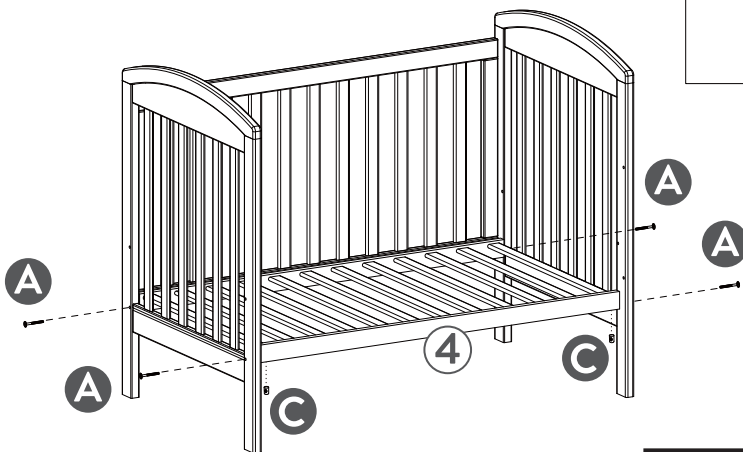
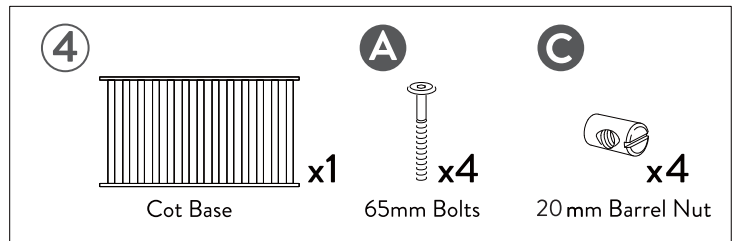

## ⚠ WARNING ⚠

TO PREVENT FALLS OR SUFFOCATION, THE MAXIMUM MATTRESS THICKNESS SHOULD NOT EXCEED 130MM

## ⚠ WARNING ⚠

TO PREVENT FALLS, THE MATTRESS BASE OF THIS COT SHOULD BE ADJUSTED TO THE LOWEST POSITION BEFORE CHILD CAN SIT UP.

# STEP 3

**!** Screw four guide pins into the End Panels firmly

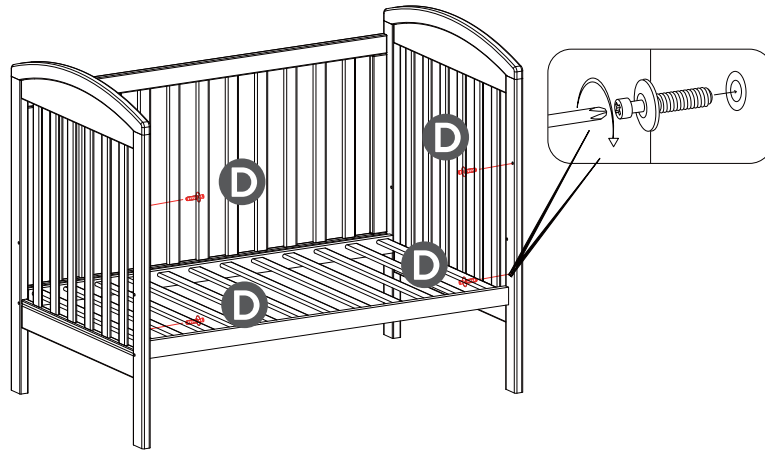
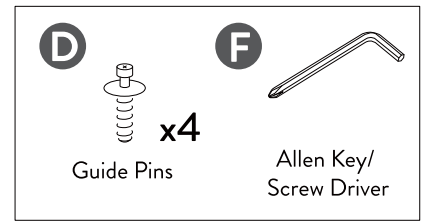

# STEP 4

## ASSEMBLE DROP SIDE

Align two access holes in the built-in runner with the guide pins on one end. Now repeat on other end.

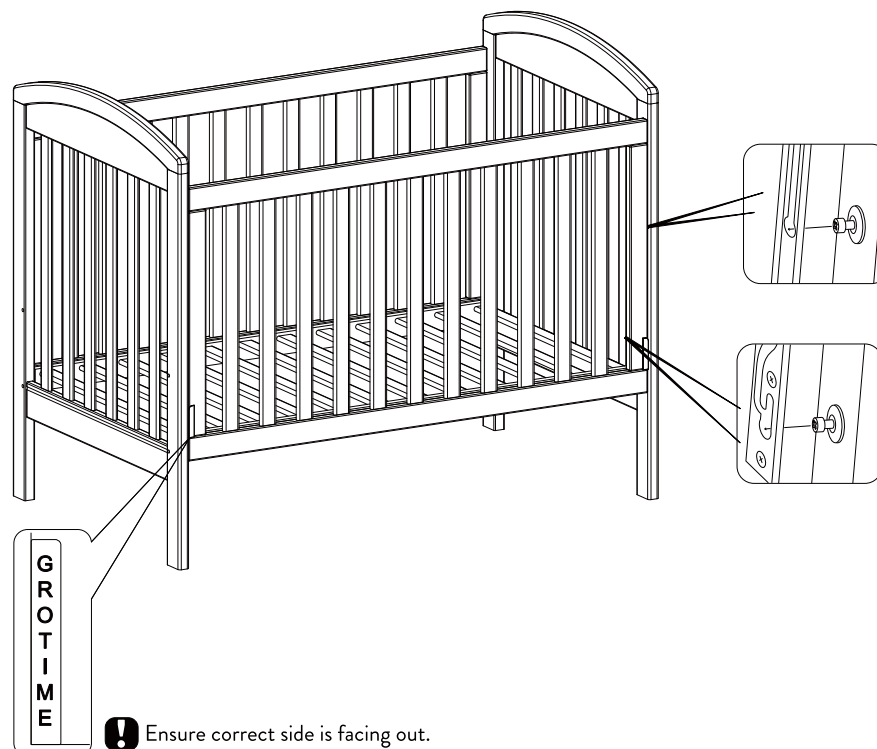

## STEP 5

### FULLY SCREW IN LOCKING BOLTS

a: Lift drop side up until it clicks into the locking position.

b: Tighten Locking bolts

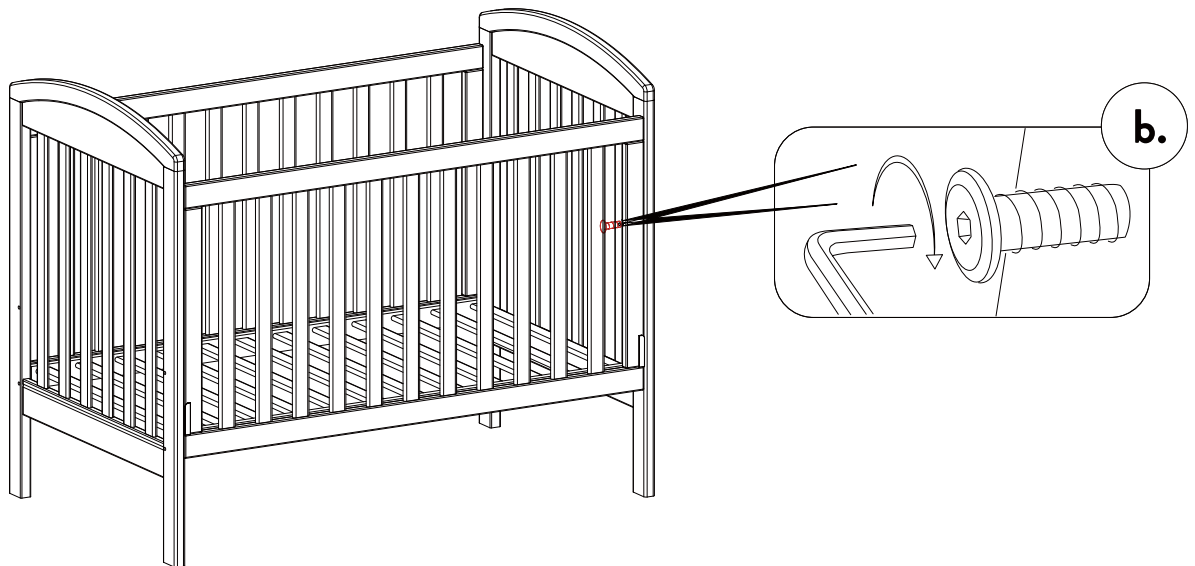

## STEP 6

### OPERATION

To lower drop side, lift from centre of top rail, hold side in that position while using your leg to push inward on centre of bottom rail. Then allow to slide gently down.

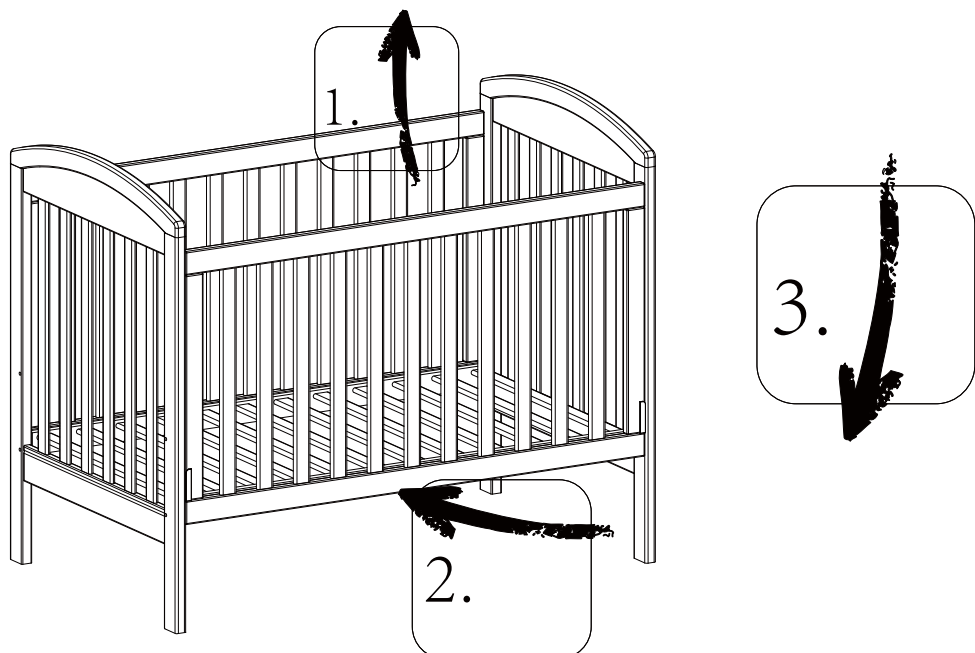

# STEP 7

Plug finger entrapments using 4 x 16mm Bolts

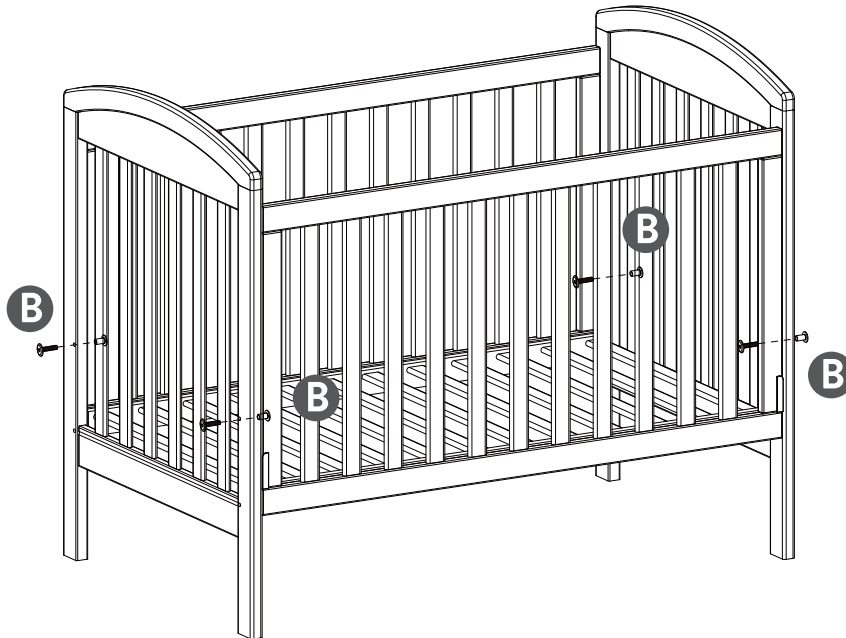
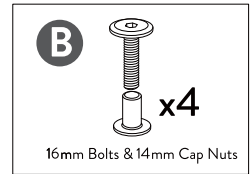

Tighten All Bolts

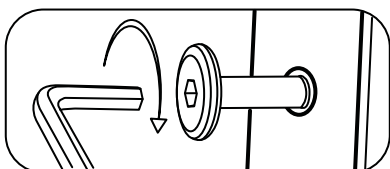
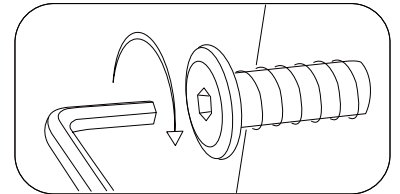

## ⚠ WARNING ⚠

ENSURE YOUR CHOSEN LOCATION FOR THE COT IS A REASONABLE DISTANCE FROM CURTAINS, BLINDS, HEATERS, AND POWER POINTS. ALWAYS KEEP MEDICATION, STRING, ELASTIC, SMALL TOYS OR SMALL ITEMS SUCH AS MONEY OUT OF REACH FROM ANY POSITION IN THE COT.

## WARRANTY

Infa Group Pty Ltd warrants this product for 3 years from the date of purchase against failure due to manufacturing faults or faulty materials. Misuse, accidental damages, normal wear and tear are not covered by this warranty. When used for commercial use this period is limited to six months. "Our goods come with guarantees that cannot be excluded under the Australian Consumer Law. You are entitled to a replacement or refund for a major failure and for compensation for any other foreseeable loss or damage. You are also entitled to have the goods repaired or replaced if the goods fail to be of acceptable quality and the failure does not amount to a major failure.

## STORAGE:

To store your 30234/30235, please reverse assembly steps. Ensure all components are kept together along with Instruction manual for future use.

## KEEP BOOKLET FOR FUTURE REFERENCE

READ ALL INSTRUCTIONS CAREFULLY BEFORE USE OF THIS COT.  
ALWAYS FOLLOW THE INSTRUCTIONS. THE CORRECT USE AND  
MAINTENANCE OF THIS PRODUCT IS ESSENTIAL.

THIS PRODUCT IS NOT INTENDED FOR COMMERCIAL USE.

INFA GROUP PTY LTD  
ABN: 52 149 173 660  
110 -114 Old Bathurst Rd,  
Emu Plains, NSW 2750

CUSTOMER CARE  
AU: 1300 92 4632  
NZ: 067 590 870  
Email: [customercare@infa.com.au](mailto:customercare@infa.com.au)

MADE IN CHINA  
MODEL NO: 30234/30235  
ISSUE B