

Secure Safe

INFA GROUP

ISOFIX
COMPATIBLE



CS8713

SUITABLE FROM BIRTH TO FOUR YEARS*

REARWARD FACING

(Rearward Facing) Suitable for children from birth to approximately 30 months* of age.

(Forward Facing) Suitable for children from 12 months of age to approximately 4 years* of age.

Instruction Manual

**IMPORTANT: KEEP THIS BOOKLET IN THE PLACE PROVIDED
ON THE CHILD RESTRAINT**

*All references to age are approximates only and reference to children of average proportions. Children vary in shapes and sizes. The photo displayed is indicative of the type of restraint and may vary slightly depending on the model.



**Australian
Standard**

AS/NZS: 1754:2013
Licence No. 25324-1
SAI Global

Rearward Facing Mode Seat Belt Installation (Use For Infant)

SETUP

REFER TO PAGES 13 - 20

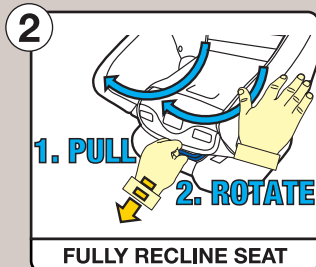
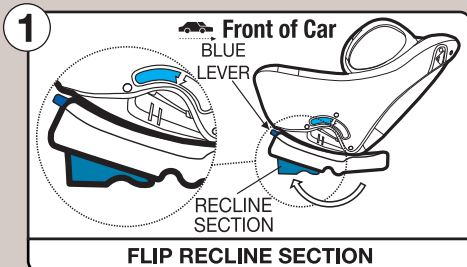

SLOT SELECTION

REFER TO PAGE 17 - 19

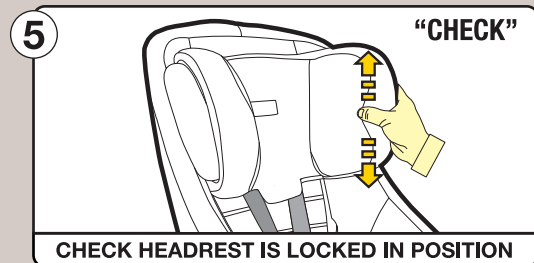
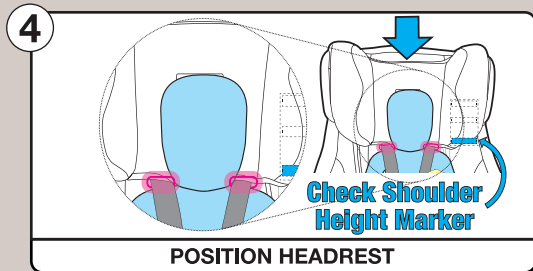
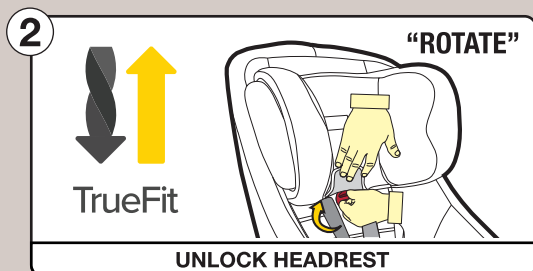
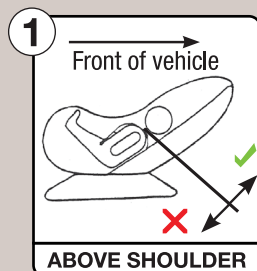

Rearward Facing Mode Seat Belt Installation (Use For Infant)

INSTALLATION

REFER TO PAGES 26 - 29

1

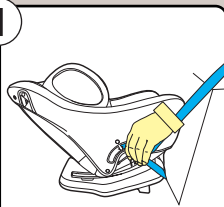

SEATBELT PATH

2

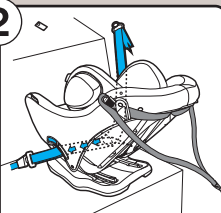

ROUTE SEATBELT

3

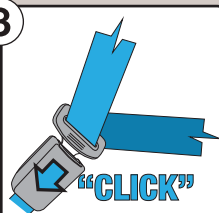

CLICK SEATBELT

4

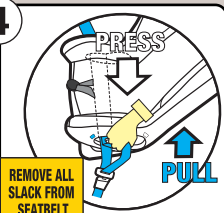

REMOVE ALL SLACK FROM SEATBELT

TENSION SEATBELT

5

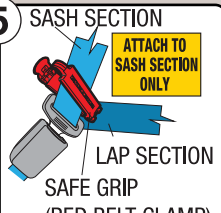

SASH SECTION

ATTACH TO SASH SECTION ONLY

LAP SECTION
SAFE GRIP
(RED BELT CLAMP)

LOCKING CLIP

6

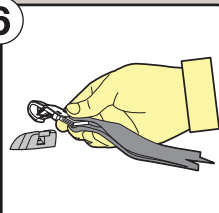

ATTACH TETHER

7

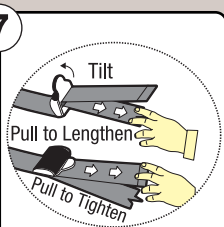

REMOVE SLACK

8

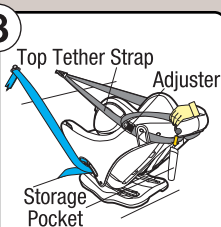

Top Tether Strap
Adjuster
Storage Pocket

STORE TETHER

Rearward Facing Mode Seat Belt Installation (Use For Infant)

USE

REFER TO PAGES 30 - 33

1 PULL TO LENGTHEN PULL TO LENGTHEN

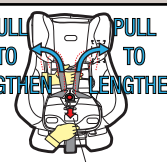

HARNES ADJUSTER
"LIFT" TO LENGTHEN
LOOSEN HARNES

2

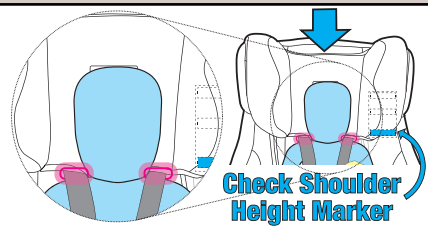

Check Shoulder Height Marker

CHECK HEADREST / SLOT POSITION

3

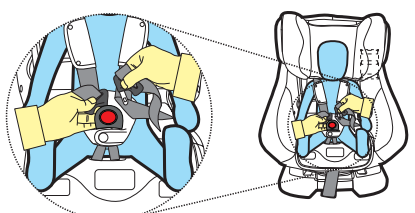

POSITION CHILD & CLIP BUCKLE

4



REMOVE ALL SLACK FROM HARNES

TENSION HARNES

5

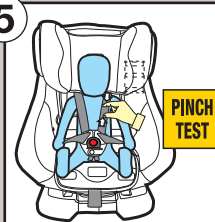

PINCH TEST

6

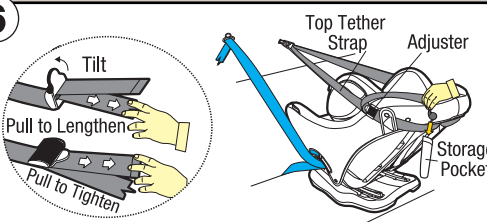

Tilt
Pull to Lengthen
Pull to Tighten

Top Tether Strap
Adjuster
Storage Pocket

REMOVE SLACK & STORE TETHER

ISOFIX Rearward Facing Mode (Use For Infant)

SETUP

REFER TO PAGES 13 - 20

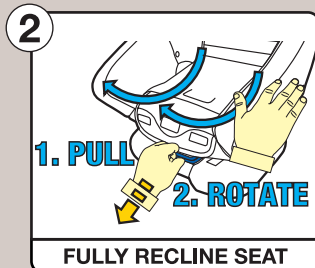
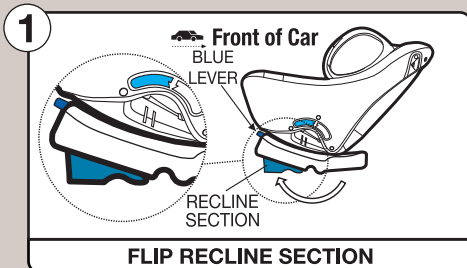

SLOT SELECTION

REFER TO PAGE 16 - 18

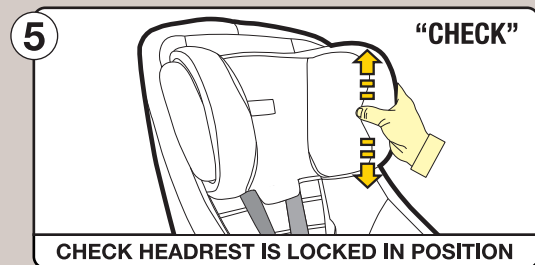
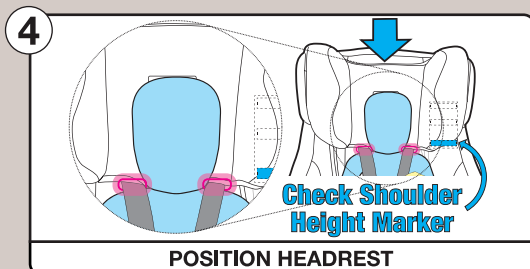
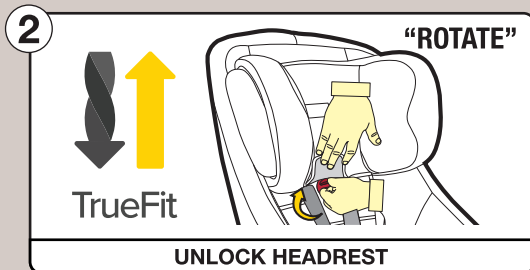
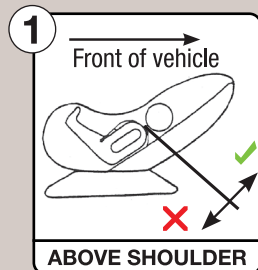

ISOFIX Rearward Facing Mode (Use For Infant)

INSTALLATION

REFER TO PAGES 21 - 25

1

Front of Car

Recline Section

Recline Section (Swing Forward) & child restraint fully reclined.

RECLINE SECTION

2

PUSH

PUSH

ATTACH ISOFIX

3

Green Indicator

PUSH

PULL

TENSION

4

PULL

LAC Strap

REMOVE ALL SLACK FROM SEATBELT

REMOVE SLACK

5

ATTACH TETHER

6

Tilt

Pull to Lengthen

Pull to Tighten

Top Tether Strap

Adjuster

Storage Pocket

Flexible LAC strap

REMOVE SLACK & STORE TETHER

ISOFIX Rearward Facing Mode (Use For Infant)

USE

REFER TO PAGES 30 - 33

1 PULL TO LENGTHEN PULL TO LENGTHEN

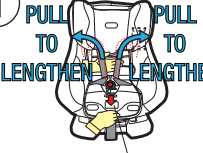

HARNESSES ADJUSTER
"LIFT" TO LENGTHEN
LOOSEN HARNESSES

2

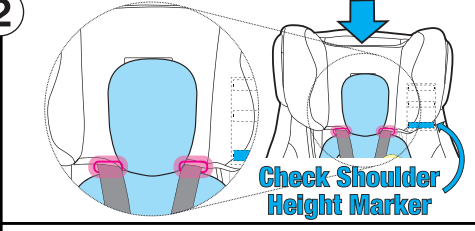

Check Shoulder Height Marker

CHECK HEADREST / SLOT POSITION

3

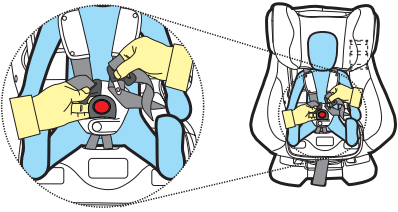

POSITION CHILD & CLIP BUCKLE

4



REMOVE ALL SLACK FROM HARNESSES

TENSION HARNESSES

5

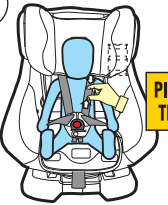

PINCH TEST

6

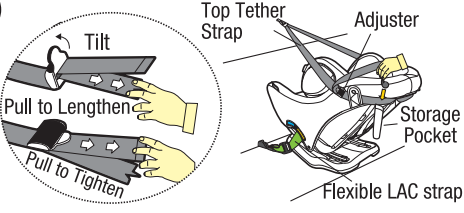

Tilt
Pull to Lengthen
Pull to Tighten

Top Tether Strap
Adjuster
Storage Pocket
Flexible LAC strap

REMOVE SLACK & STORE TETHER

Forward Facing Mode Seat Belt Installation (Use For Child)

SETUP

REFER TO PAGES 39 - 43

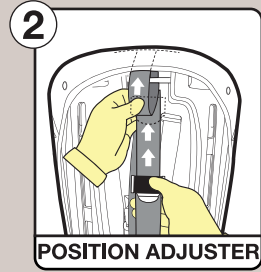
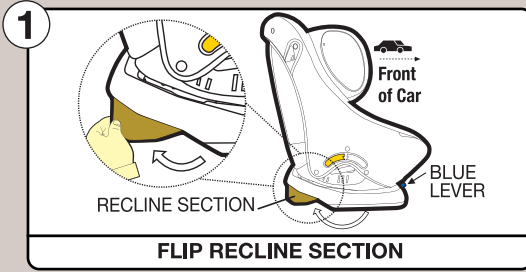

SLOT SELECTION

REFER TO PAGES 40 - 42

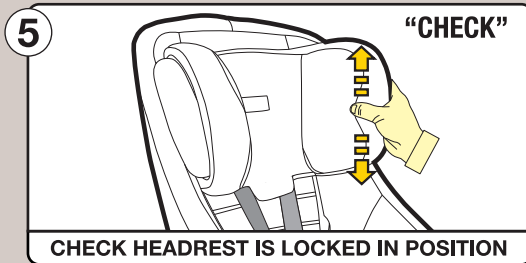
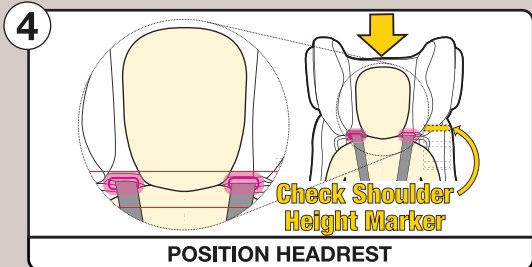
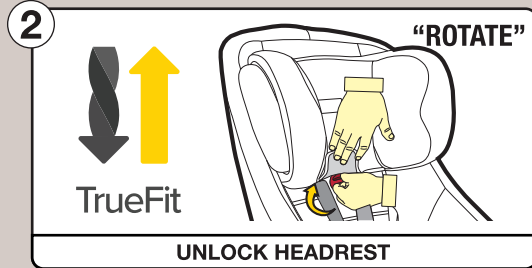
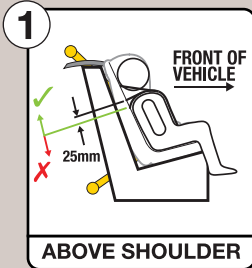

Forward Facing Mode Seat Belt Installation (Use For Child)

INSTALLATION

REFER TO PAGES 48 - 51

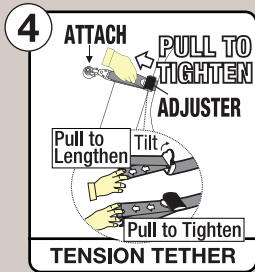
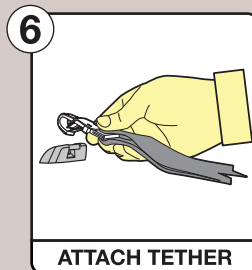
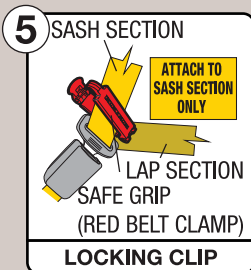
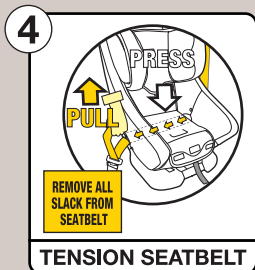
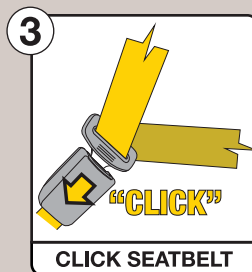
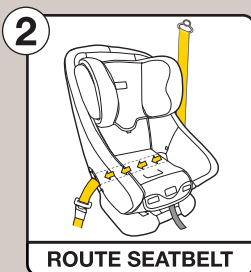
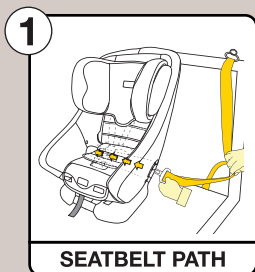

Forward Facing Mode Seat Belt Installation (Use For Child)

USE

REFER TO PAGES 52 - 54

1 PULL TO LENGTHEN PULL TO LENGTHEN

HARNESS ADJUSTER
"LIFT" TO LENGTHEN
LOOSEN HARNESS

2

Check Shoulder Height Marker

CHECK HEADREST / SLOT POSITION

3

POSITION CHILD & CLIP BUCKLE

4

REMOVE ALL SLACK FROM HARNESS

"Pull" to tighten

TENSION HARNESS

5

PINCH TEST

6

Tilt

Pull to Lengthen

Pull to Tighten

ATTACH

PULL TO TIGHTEN

ADJUSTER

TENSION TETHER

ISOFIX Forward Facing Mode (Use For Child)

SETUP

REFER TO PAGES 39 - 43

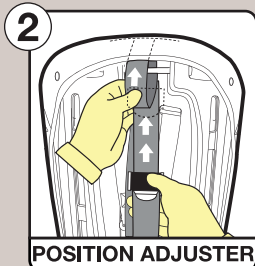
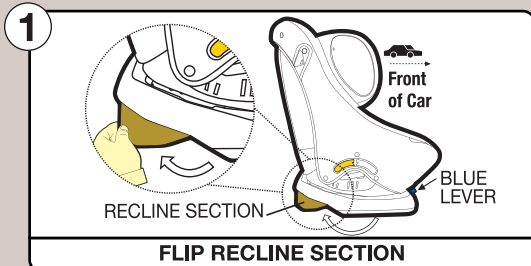

SLOT SELECTION

REFER TO PAGES 40 - 42

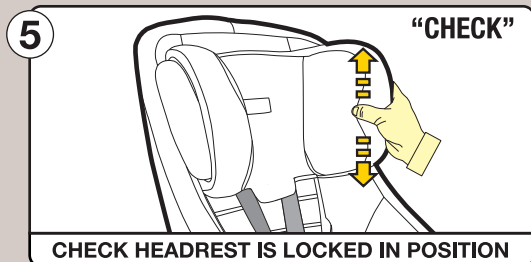
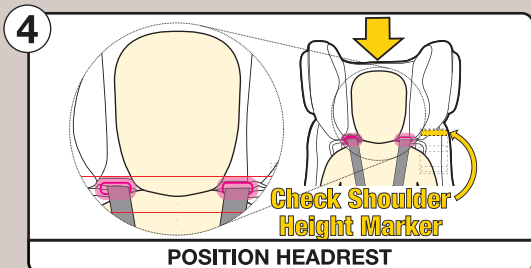
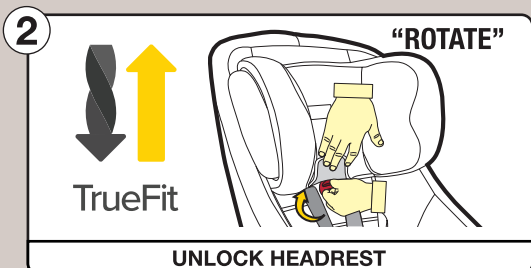
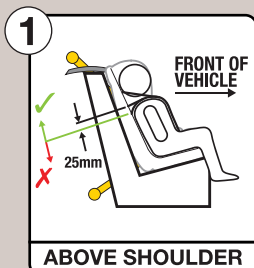

ISOFIX Forward Facing Mode (Use For Child)

INSTALLATION

REFER TO PAGES 44 - 47

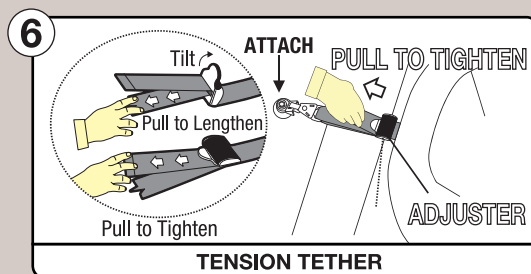
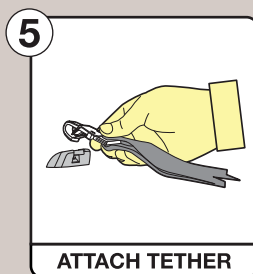
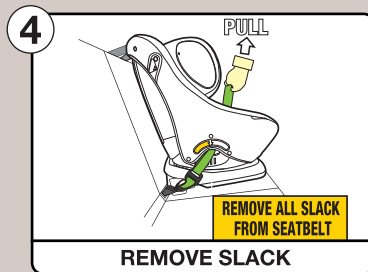
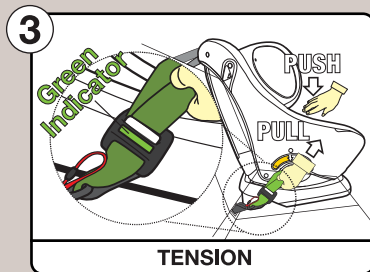
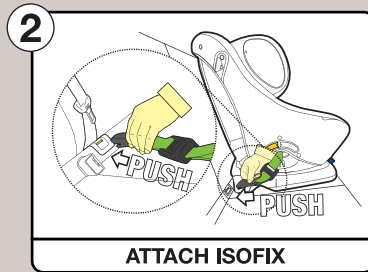
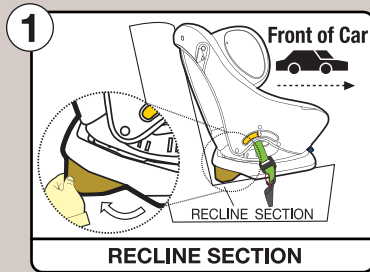

ISOFIX Forward Facing Mode (Use For Child)

USE

REFER TO PAGES 52 - 54

1 PULL TO LENGTHEN PULL TO LENGTHEN

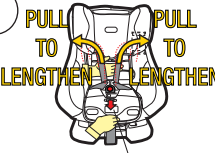

HARNESS ADJUSTER
"LIFT" TO LENGTHEN
LOOSEN HARNESS

2

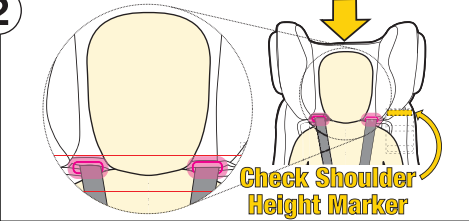

Check Shoulder Height Marker

CHECK HEADREST / SLOT POSITION

3

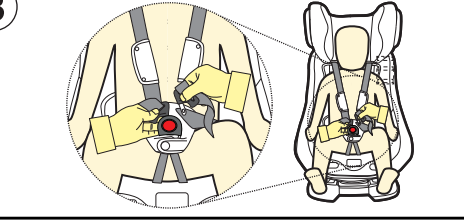

POSITION CHILD & CLIP BUCKLE

4

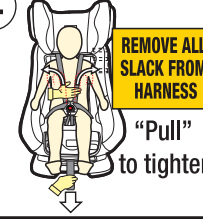

REMOVE ALL SLACK FROM HARNESS

"Pull" to tighten

TENSION HARNESS

5

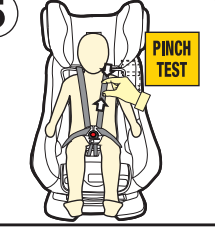

PINCH TEST

PINCH TEST

6

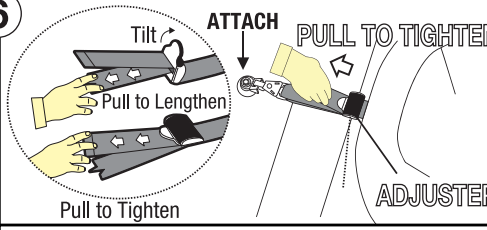

Tilt

Pull to Lengthen

Pull to Tighten

ATTACH

PULL TO TIGHTEN

ADJUSTER

TENSION TETHER

Contents

Contents	1
Information	2
Warnings	5
Restraint Guide	7
Padding - Combination Guide	8

Infant Seat

Information	9
CS8713 Child Restraints (Itemised List)	10
Shoulder Height Markers	11
Setup	
- General	13
- Selection of Appropriate Padding Combinations	14
- Converting to Infant Seat	14
- Recline Angle	16
- Shoulder Height	17
- Headrest & Harness Strap Height Adjustment	18
- Buckle Height Adjustment	20

ISOFIX Compatible Restraint

- ISOFIX Lower Anchorages	21
- Accessing the Flexible ISOFIX Lower Anchorage Connectors	22
- Installing using Flexible ISOFIX Lower Anchorage Connectors	23
Installation	
- Installing Using Vehicle Seatbelts	26
Use	
- Using Inbuilt Harness	30
- To Release Infant	33

Child Car Seat

Information	34
Shoulder Height Markers	35
CS8713 Child Restraints (Itemised List)	37
Next Restraint	38
Setup	
- Selection of Appropriate Padding Combinations	39
- Converting to Child Car Seat	39
- Shoulder Height	40
- Headrest & Harness Strap Height Adjustment	41
- Buckle Height Adjustment	43

ISOFIX Compatible Restraint

- ISOFIX Lower Anchorages	44
- Accessing the Flexible ISOFIX Lower Anchorage Connectors	45
- Installing using Flexible ISOFIX Lower Anchorage Connectors	46
Installation	
- Installing Using Vehicle Seatbelt	48
Use	
- Using Inbuilt Harness	52
- To Release Child	54

Care of Restraint	
- Care and Maintenance	55
- Cleaning	56
Remove & Replace Covers	58
Extension Straps	60
Accessories	61
Anchorage Fittings	64
Insurers Information	66
Lifetime Warranty	70

Information

This instruction manual covers various models under the Model number CS8713. These child restraints are installed in the rear of the vehicle and can be used either rearward-facing or forward-facing. They can either be installed in the vehicle using the vehicle seatbelt & the top tether strap, or if applicable, the flexible Lower Anchorage Connector (LAC) straps attached to the vehicle's ISOFIX anchor & top tether strap. This Convertible Car Seat is designed to be used by children from birth up to approximately 4 years of age.

Infa Group

Infa Group is a family owned and operated business located in Sydney, Australia. With over 65 Years experience in Juvenile Products, our mission is to deliver Safety and Innovation.

Infa Group strives to create a real difference for our customers. We design and manufacture safe, stylish and affordable Child Restraints and Nursery products. All products are engineered to a high quality and standard so that your young ones will be secure in an Infa Group product.



Child Restraints

No child restraint can guarantee absolute protection from injury in every crash. However, to ensure that your child gets all the protection designed into the restraint please read and follow the instructions exactly and use only SecureSafe recommended parts and accessories.



Information

Protect Plus

Protect Plus is a family of safety technologies, designed to work in unison to protect your child in the event of an accident.

Armour Tech

Armour Tech is the foundation of our Protect Plus System. It is a layer of air held within the entirety of the child restraint shell. This cocoon of air provides an increased level of protection across the entire surface area of the restraint, which compliments and elevates the performance of *Side Impact Pod* and *Active Air Pad*.

Side Impact Pod

Side Impact Pod is a safety technology integrated directly into the child restraint headrest. It is designed to offer superior structural integrity, advanced impact management, and optimal positioning of your child's head in the event of an accident. It adds additional air cushioning between your child's head and the impact point, keeping them as far from harm as possible.

Active Air Pad

Active Air Pad adds a third, soft layer of protection to your child. It cushions the head, gently expelling air before the 8 shock absorbing domes further dissipate crash forces. In conjunction with Armour Tech, Active Air Pad reduces crash energy to well below the requirements of the Australian Standard.



Complete Safety System



Information

TrueFit

TrueFit allows one-handed adjustment of the headrest and harness from the front of the restraint. No re-threading straps, no uninstalling - you can get the perfect fit in seconds, and it's never been easier



TrueFit

Harness Adjustment System

ISOFix

ISOFix compatible installation allows you to use your vehicles ISOFix compatible anchorage points, allowing for a secure, easy installation.



ISOFix

compatible installation

EasyBelt

The EasyBelt patented belt path allows for extremely quick and easy installation with your vehicle's seatbelt.



EasyBelt

Easy Install Beltpath

Advanced Contour Cover

The Advanced Contour Cover provides ultimate airflow around your child and the highest degrees of comfort.



Advanced Contour Cover

Ultimate airflow and comfort

Warnings



WARNINGS

- Use the restraint exactly as shown in the instructions.
- Supervision of children is needed because they may be able to undo buckles.
- **DO NOT LEAVE CHILDREN UNATTENDED IN THE CAR.**
- Do not alter or modify this restraint.
- Repairs must only be done by the manufacturers or agent.
- Do not allow the restraint to come into contact with polishes, oils, bleach and other chemicals.
- Destroy the restraint if it has been in a severe crash, even if no damage is visible.
- **DO NOT USE THIS RESTRAINT WITHOUT THE COVER.**
- To ensure infant's back is evenly supported, do not put more than one nappy on the baby and make sure the nappy is not thickly folded at the back.
- **DO NOT USE A REAR-FACING CHILD RESTRAINT WHERE AN AIRBAG IS FITTED IN FRONT OF THE SEATING POSITION.**
- Fit the restraint firmly to the car seat.
- Fit the harness firmly to the child.
- A loose restraint or harness is dangerous.
- Do not harness an infant wrapped in a blanket or swaddled. Any blanket or wrap must only be placed over the harness and infant.
- Always secure the loose end of the top tether strap. Do not use the child restraint where this strap may fall into a split in the seat back or off the side of the seat.
- **ALWAYS ATTACH HOOK AND REMOVE SLACK.**

For use in other countries other than Australia and New Zealand

- The child restraint may not be accepted for use in cars.

- Consult the country's local authorities, car hire companies, car insurance companies, etc. for advice.

Please read carefully the whole of the instructions for installation and, in the event of doubt about the method of installation, to consult SecureSafe or agent, or a child restraint fitter, or in New Zealand, to consult the agent for the vehicle.

Warnings



WARNINGS

- THIS RESTRAINT IS NOT SUITABLE FOR USE WHERE THE TOP TETHER STRAP MAY FALL INTO A SPLIT IN THE SEAT BACK OR OFF THE SIDE OF THE SEAT.
- THIS RESTRAINT MUST BE ATTACHED TO A CHILD RESTRAINT UPPER ANCHORAGE POINT IN THE CAR. REFER TO CAR OWNER'S HANDBOOK FOR LOCATION OF ANCHORAGE POINTS. REFER TO A CHILD RESTRAINT FITTING STATION IF NO ANCHORAGE POINTS ARE IN THE MOTOR CAR.
- Always secure the loose end of the top tether strap to prevent it hanging out of the car or being accessible by the child. Do not use the child restraint where this strap may fall into a split into the seat back or off the side of the seat.
- IF AN AIRBAG IS FITTED IN THE SEATING POSITION WHERE THE CHILD RESTRAINT IS TO BE FITTED, FOLLOW THE VEHICLE MANUFACTURER'S WARNINGS AND INSTRUCTIONS.



IMPORTANT

Do not attach the lower attachment connectors of two separate child restraints to the same ISOFIX low anchorages in your car.

Always attach the top tether strap to the child restraint upper anchorage in your car.

Child restraint lower attachment connectors and the ISOFIX low anchorages in your car are designed to withstand only those loads imposed by a correctly fitted child restraint.



WARNING

DO NOT LEAVE CHILDREN UNATTENDED IN THE CAR.



IMPORTANT

There is a real potential for an infant to be ejected and killed if the baby is wrapped in a blanket or swaddled. The harness need to fit the baby firmly and any blanket or other covering may only be placed over the harness after the harness is adjusted firmly. Please ensure the baby's arms and legs are not bound or wrapped together.

Restraint Guide

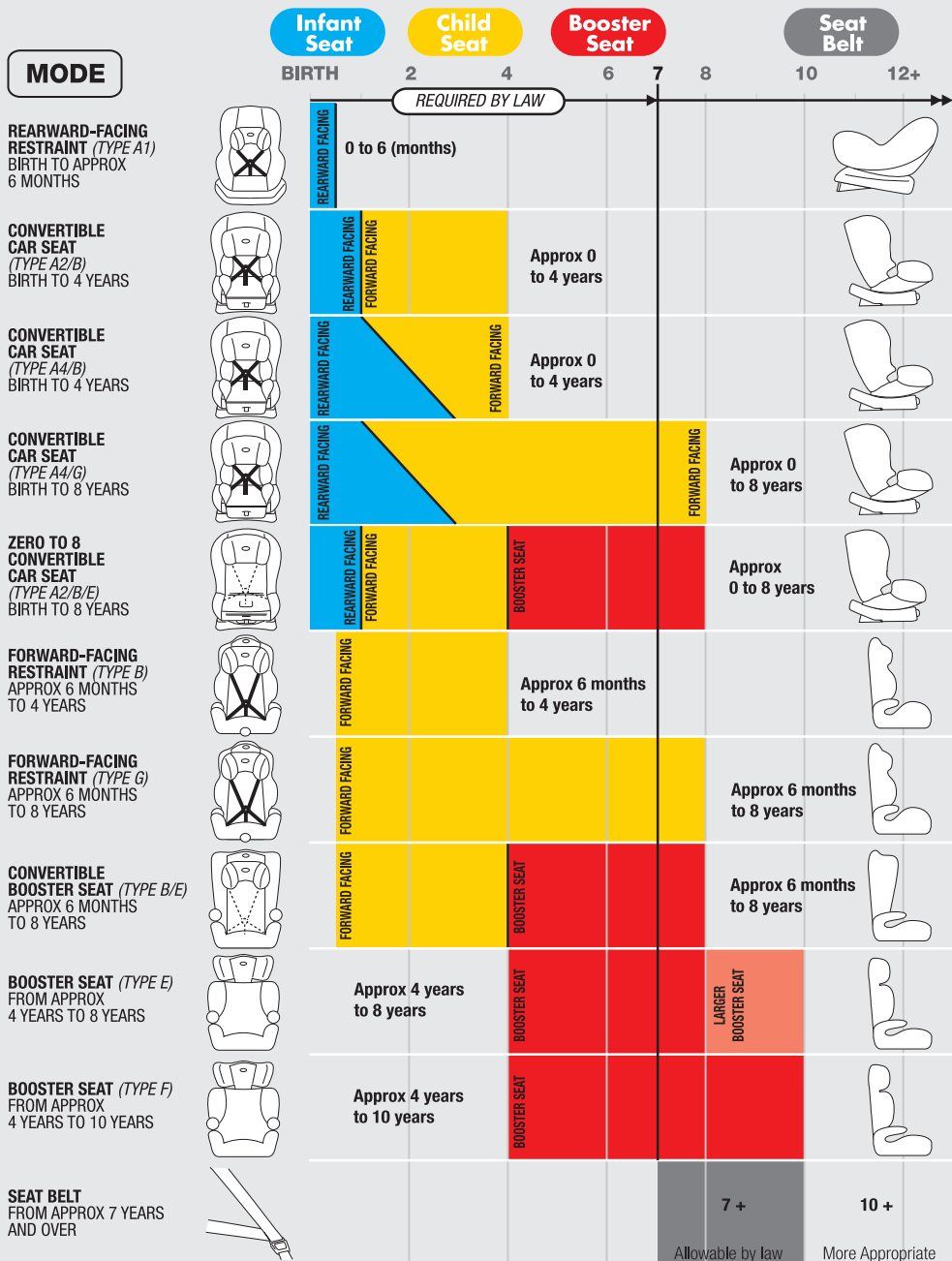

IMPORTANT: Research has shown that the likelihood of an accessory child safety harness being used incorrectly is very high and the risk of injuries when incorrectly used is much higher compared to a lap-sash seat belt. SecureSafe recommend that an accessory child safety harness should only be used if a lap-only seat belt is all that is available.

Padding / Inserts

Combination Guide

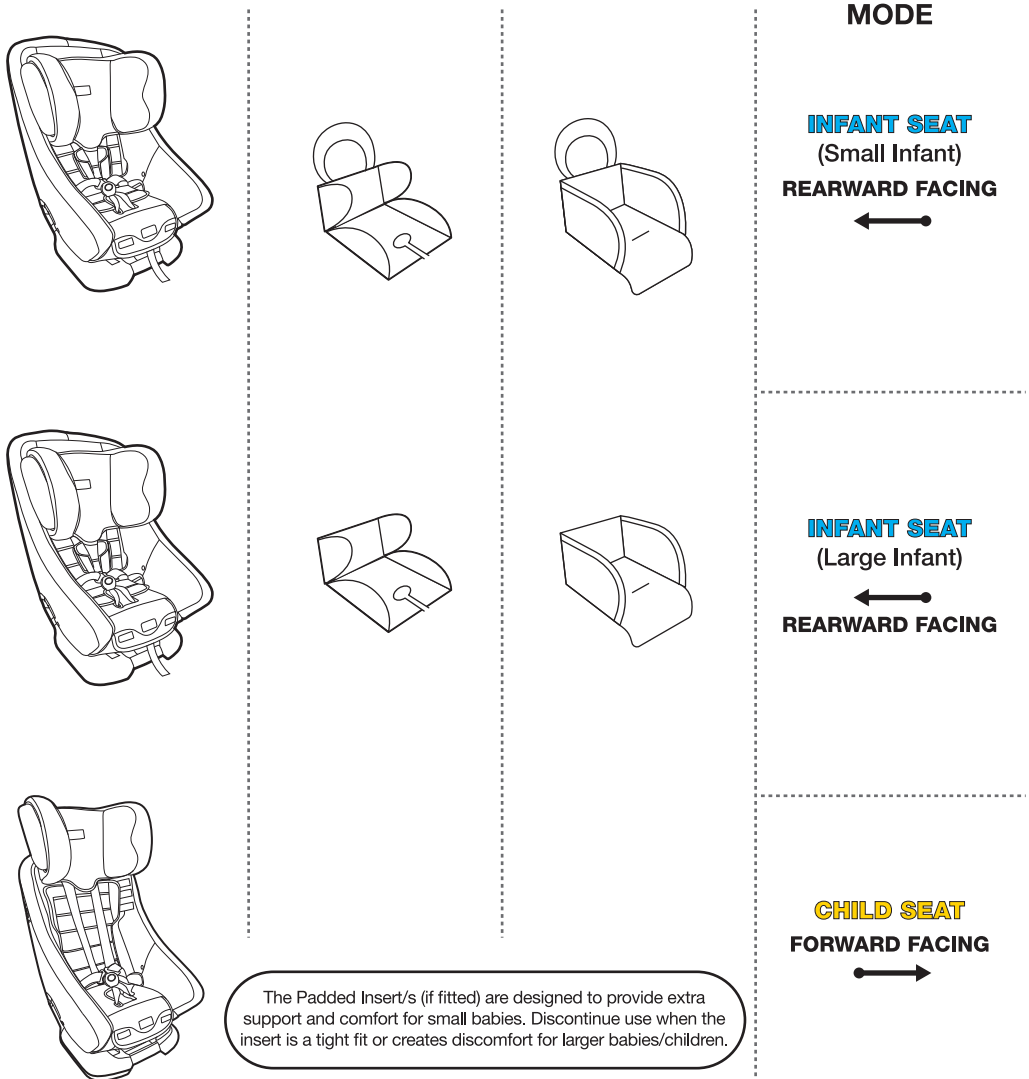

- Diagrams are indicative of type of paddings and inserts and may not resemble the actual product.
- Padded inserts can vary according to model.
- We reserve the right to alter this product without notice.

*For detailed description and method of attachment for padded accessories refer to Accessories on page 61.

THE SUITABILITY OF THE CHILD RESTRAINT TO GROUPS OF CHILDREN

TYPE A4

To be used only in a rearward-facing position until the infant's shoulders either reach the lower shoulder height marker (approximately 12 months of age) or reach the middle height marker (approx 2 to 3 years of age).

TYPE B

Then to be used in a forward-facing position until the child's shoulders reach the upper shoulder height marker (approximately 4 years of age).

Continue to use this child restraint until the child reaches this limit.

Do not use forward-facing until child's shoulders are above the lower shoulder height marker.

Infants are at risk of serious injury if they face forward too early.

Children are at risk of serious injury if they move to booster seats too early.

Children who have outgrown this restraint are safest in a larger child restraint with an in-built harness or a booster seat until their shoulders reach the upper shoulder height marker of the restraint.

TO BE USED WITH A LAP-SASH/LAP-ONLY SEAT BELT OR ISOFIX LOW ANCHORAGES IN THE BACK OF MOST CARS WITH FORWARD FACING SEATS.

The use of child restraints in the front seat may be restricted for children of specific ages by local legislation. Please check with your local Department of Transport for the specific seating locations of children using child restraints for their given ages.



IMPORTANT

- ONLY USE RESTRAINT REARWARD-FACING
- Do not use the restraint without the upper anchorage strap correctly attached.
- DO NOT USE A REAR-FACING CHILD RESTRAINT WHERE AN AIRBAG IS FITTED IN THE FRONT OF THE SEATING POSITION.
- Do not use on any vehicle seat which faces sideways or rearward.
- Do not use the child restraint facing forward.
- Do not use excessively upright or reclined.
- For a vehicle without a fixed parcel shelf an extension strap(s) may be needed. If so ring 1300 92 4632 (AU) or 067 590 870 (NZ) for nearest supply location (refer to page 60).
- Seatbelt extenders are not recommended to be used if the seatbelt is not long enough to secure the child restraint. If seatbelts are too short then advice should be sought from a child restraint fitter and their recommendation be considered before using a seatbelt extender.

Model CS8713

Infant Seat

Rearward Facing

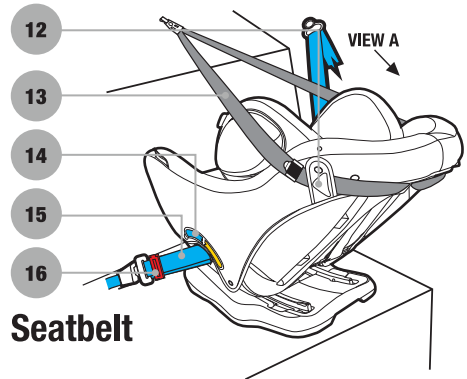
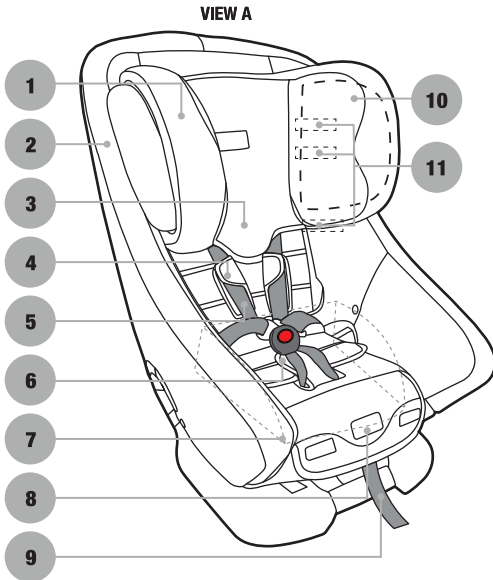

Seatbelt

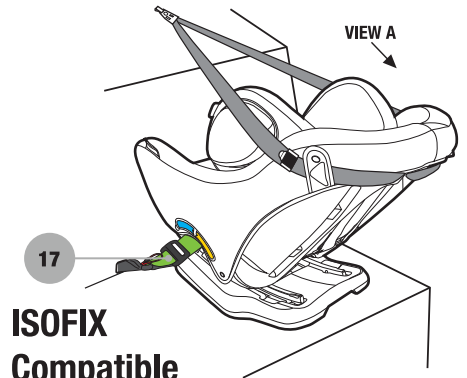

ISOFIX Compatible

1. Adjustable Headrest (with Protect Plus)
2. Comfort Covers
3. "TrueFit" Headrest + Harness adjustment system
4. Shoulder Pads
5. Harness Straps
6. Buckle Pad
7. Padded Insert (if fitted)
8. Harness Adjuster
9. Harness Adjustment Strap
10. Active Air Pads (if fitted)
11. Shoulder Height Markers
12. Top Tether Guide
13. Top Tether Assembly
 - Tether Strap
 - Adjuster
 - Attachment Clip
 - Anchor Fitting + Attachment Hardware
14. "REARWARD-FACING SEAT BELT PATH" Marker (each side of restraint - coloured blue)
15. Vehicle Seat belt
16. Safe Grip Red Belt Clamp (if supplied with restraint)
17. ISOFIX Compatible Lower Attachment Connectors (LAC)

NOTE: Padded inserts can vary according to model. For detailed description and method of attachment for padded accessories refer to Accessories on page 61.

Shoulder Height Markers

Infant Seat

Rearward Facing

Infant (Rearward Facing Mode)

Shoulder height markers are provided on this restraint for a visual indication that the child is safe to travel in this restraint. Do not turn to forward facing until the child's shoulder reaches the lower label.

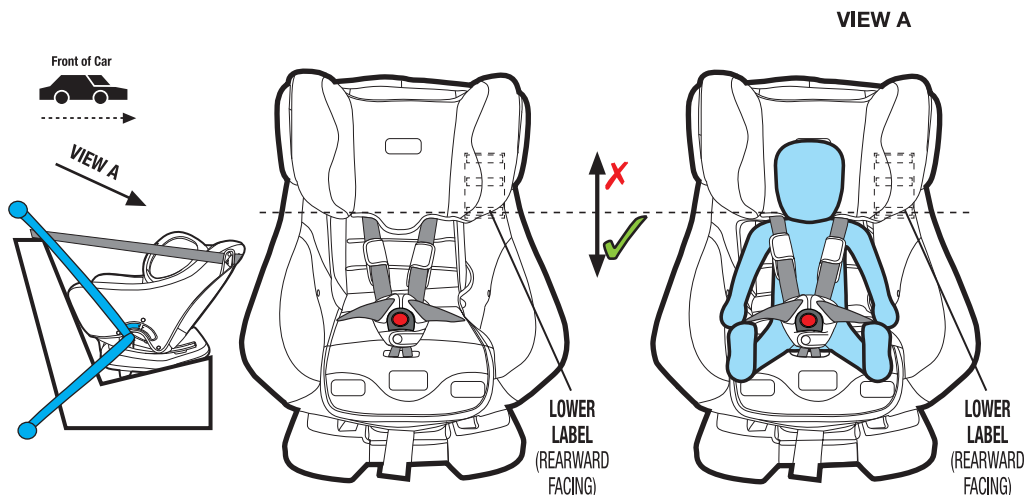

Shoulder height markers may be hidden under the headrest in the lowest position

To be used only in a rearward-facing position for an infant until their shoulders **REACH** the Lower shoulder height marker (approximately 12 months of age).

LOWER LABEL (Rearward-Facing)



IMPORTANT

Ensure that you continue to use this child restraint in rearward facing positions whilst the infants shoulders are **below** this shoulder height marker (Lower label).

Infants are at risk of serious injury if they face forward too early.

If the infants shoulders are below the lower label or if the baby's neck muscles are unable to support their head, then the infant should remain rear facing. When the child's shoulder reach the lower label, the child restraint may be turned to face towards the front of the car (refer page 34 Child Seat section).

Shoulder Height Markers

Infant Seat

Rearward Facing

Infant (Rearward Facing Mode)

This restraint must remain rear facing until the child reaches the lower shoulder height marker (approx 12 months old). Once the child's shoulders reached the lower shoulder height marker the restraint can either

- Remain **REARWARD FACING** until the middle shoulder height marker is reached (approx 2 to 3 years) or
- Change to **FORWARD FACING** until the upper shoulder height marker is reached (approx 4 years old).

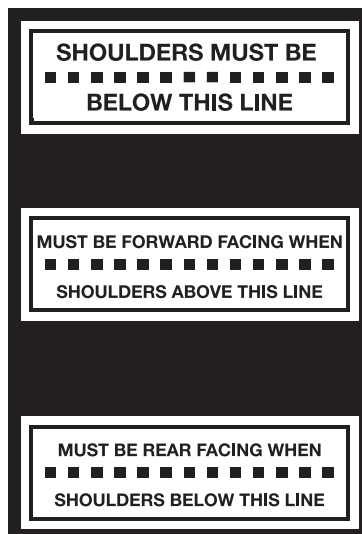
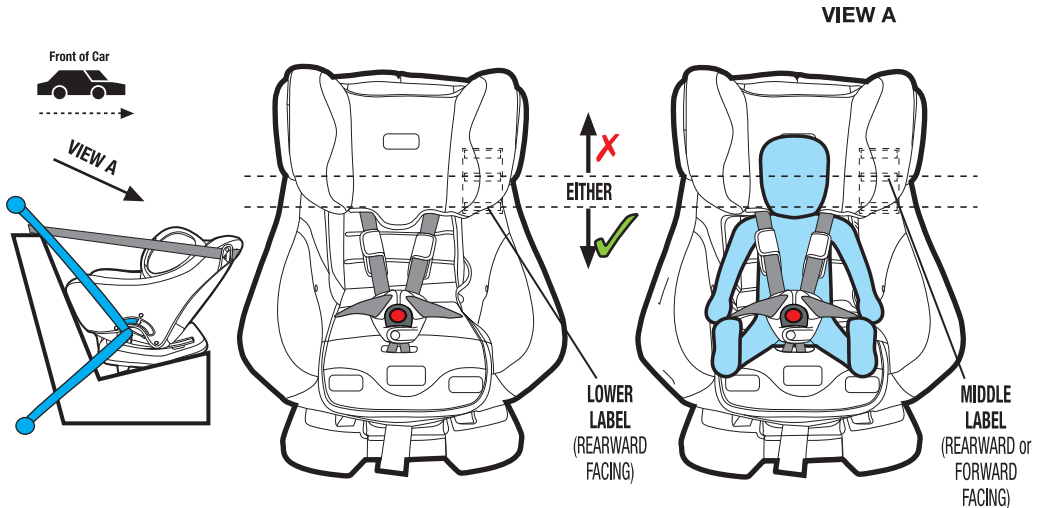

FORWARD FACING
between these lines.

Either **FORWARD FACING**
or **REARWARD FACING**
between these lines.

REARWARD FACING
below this line.

SecureSafe recommends to use this restraint in **REARWARD FACING** mode as long as possible.

General

- The CS8713 Child restraint has been designed and tested to meet the joint Australian/New Zealand Standard with an inbuilt anti rebound feature and does not require additional anti rebound bars or mechanisms to fulfil these requirements.
- The CS8713 Child restraint has also been designed to be a compact restraint to enable multiple restraints to be used in the rear of most vehicles.

IMPORTANT

- Care and attention should be given to ensure that the baby has adequate ventilation and shading when in the restraint.
- To achieve the necessary distribution of deceleration forces during a vehicle impact, ensure the child is seated correctly in the child restraint and the harness is fitted and adjusted as per these instructions.
- Ensure the child restraint and child are rearward facing.

If the baby's neck muscles are unable to support their head, then the infant should remain rear facing.

The purchaser should check the measurement between the front of the seat back of the rear seat and all front seats in the car in which the child restraint is intended to be used, to ensure that the space is sufficient.

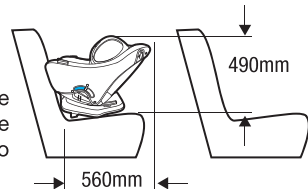

WARNING

- ONLY USE RESTRAINT IN REARWARD-FACING MODE WITH "RECLINE SECTION" SWUNG FORWARD AND RESTRAINT FULLY RECLINED.
- Do not use the restraint without the upper anchorage strap correctly attached.
- DO NOT USE A REAR-FACING CHILD RESTRAINT WHERE AN AIRBAG IS FITTED IN THE FRONT OF THE SEATING POSITION.
- Do not use on any vehicle seat which faces sideways or rearward.

Selection of Appropriate Padding Combinations

Step 1: Determine whether your infant/child requires the additional padding provided with this restraint, to ensure a safe and snug fit in the restraint. Refer to page 8 for suggested padding combinations.



WARNING

- To ensure baby's back is evenly supported, do not put more than one nappy on the baby and make sure the nappy is not thickly folded at the back.

Converting to Infant Seat

Reclined Position

Step 1: At the front of the restraint is a blue* lever. Pull the blue* lever forward and recline the restraint base as far as possible. *Colour may vary.

Step 2: Ensure the recline section is swung forward (see Figure 1).

Step 3: Ensure the In-built harness "Shoulder straps" are positioned in the appropriate slots.



IMPORTANT

- Refer to the shoulder height labels (As shown on pages 10 & 11).
- For correct shoulder strap slot height refer to page 17-19.

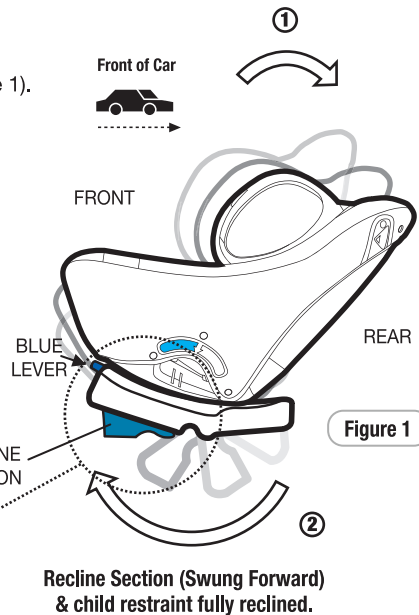
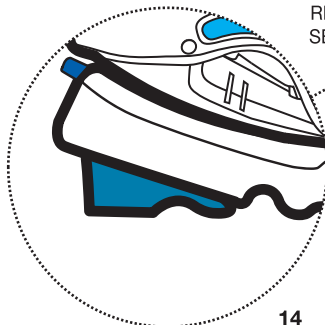

Figure 1

Converting to Infant Seat

Reclined Position

More Recline

NOTE: If you require more recline place a firm packing between the vehicle seat and the underside of the restraint.

We recommend using a TA601 Recline Foam Bar to prop the child restraint, if more recline is required. (packing could also be achieved by using a firmly rolled up towel).

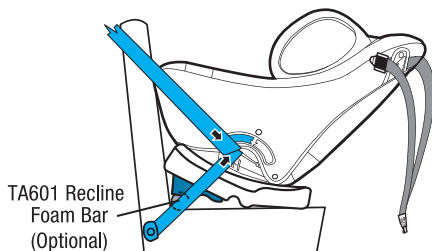

Adjuster Assembly Location

The position of the adjuster (top tether strap) is adjustable for ease of installation and ease of use.

Rearward Facing (Type A)

Step 1: Pull adjuster and strap to extend the location of the adjuster assembly (refer Figure 1).

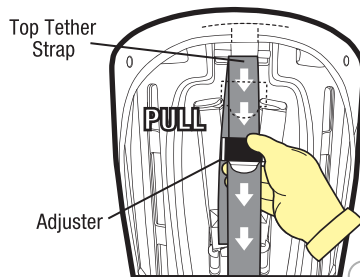

Figure 1

Step 2: Continue to extend until the adjuster has reached the desired location at the side of the restraint (refer Figure 2).

Step 3: Locate the adjuster at the side of the restraint and secure using the top tether strap guide (refer Figure 3).

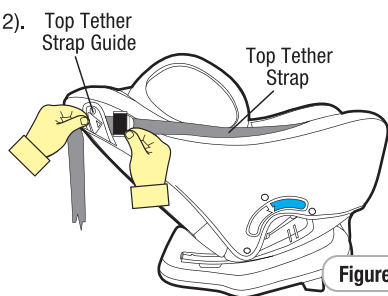

Figure 2



IMPORTANT

EASE OF USE: It is recommended to position the adjuster at the side of the restraint which is towards the access door (rear passenger side).

ALWAYS KEEP ADJUSTER IN THIS REGION

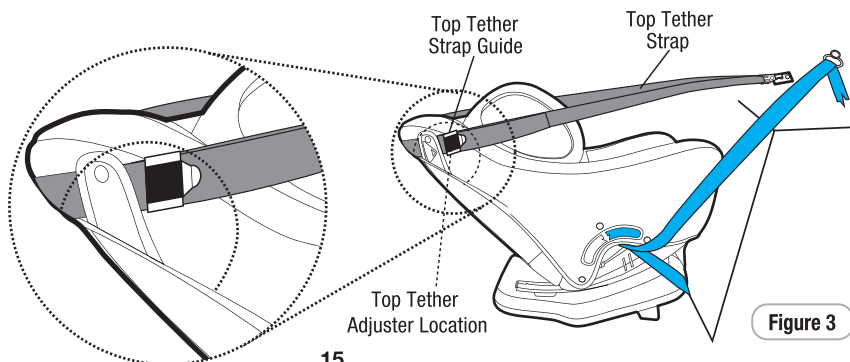

Figure 3

Recline Angle

The vehicle installation is controlled by the angle of the vehicle seat, and these angles vary greatly between vehicles. The vehicle seat angle or the contours of the vehicle seat could place the child restraint either too upright or too recline. A rearward facing restraint should always be installed so that the back surface is reclined just enough to allow the infant's head to lie back comfortably, but not more than 45° from vertical. This measurement is taken when your infant is laying in the child restraint and is in direct contact with this back surface, so it's extremely important to maintain the required angle.

IMPORTANT

Your infant should NEVER be too upright or too recline.

TOO UPRIGHT (less than 35° from vertical) could lead to the infants head flopping forward and potentially pinching off the airway.

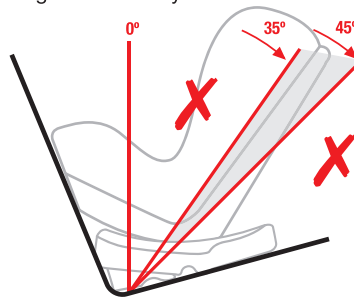

TOO RECLINED (greater than 45° from vertical) could lead to the infants body sliding 'up' towards the top of the restraint. Which could promote a compressive load on the spine and/or an extension load on the neck.

NOTE: An accurate method of measuring the recline angle of your infant is to use a smart phone with a application that can measure angles but if using this method ensure the car is on a level surface.

Shoulder Height

Zone

The child's shoulder region.

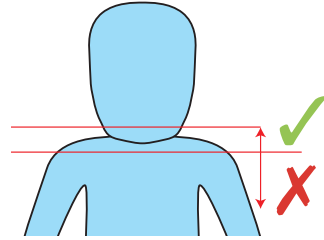

Slot Position

Nearest to the child's shoulders. Level with or just above the child's shoulders but not lower.

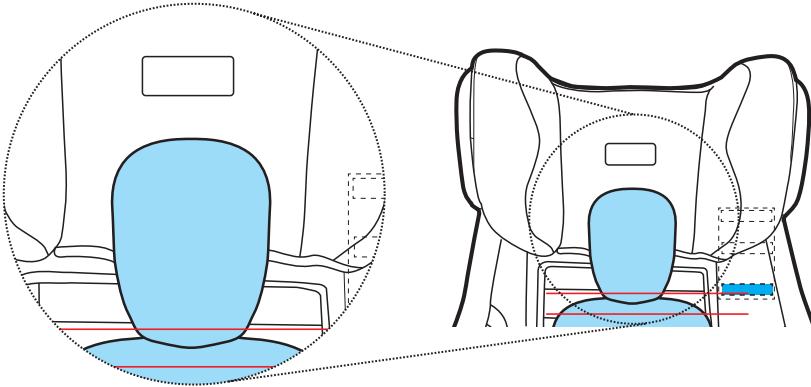

Headrest Position

Position the headrest above the shoulders, to ensure the shoulder straps are nearest to the child's shoulders.

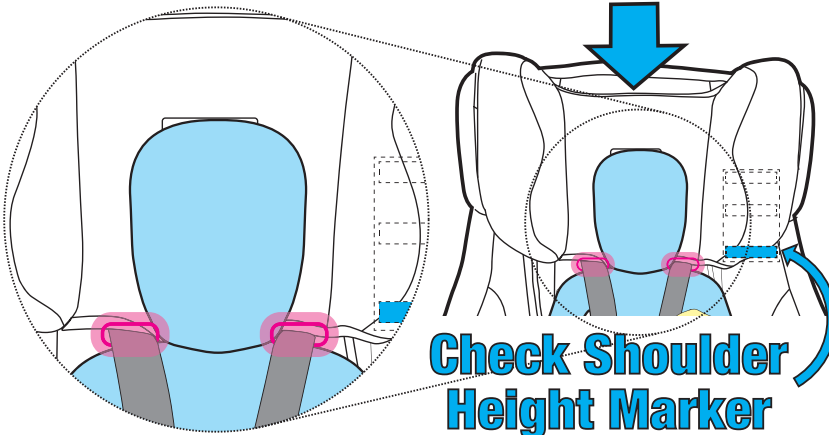

Setup

Infant Seat

Rearward Facing

Shoulder Height

The correct height for the shoulder straps is very important for the optimum performance of the restraint.



IMPORTANT

The shoulder straps must be in the slots which are nearest to the child's shoulders, but not lower than the child's shoulders.

There is only one set of slots so the seat will always have the shoulder straps in place once the headrest is positioned correctly, just above the infant's shoulders.

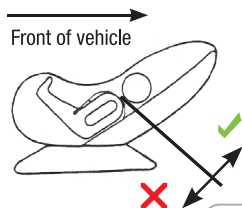

Figure 1

Headrest & Harness Strap Height Adjustment

Step 1: Loosen the harness straps before adjusting the headrest (refer "Using Inbuilt Harness" page 30).

You do not need to remove the restraint from the vehicle to adjust the harness or headrest positions.



Step 2: To adjust the headrest, lift the "TrueFit" flap on the headrest cover. Turn the red "TrueFit" knob clockwise to unlock the headrest (refer Figure 1).

Step 3: Lift up or push down the headrest so that the shoulder strap slots are level with or slightly above your child's shoulders. If the headrest is just above the shoulders then the harness level will be correct (refer Figure 2).

Step 4: Release "TrueFit" knob so that it locks into position. Ensure that it has locked in position by gently pushing down on the headrest.

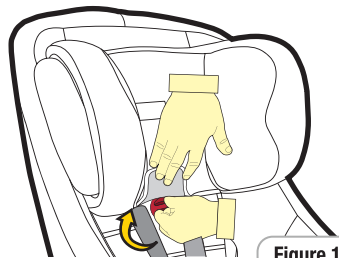

Figure 1



IMPORTANT

- For comfort ensure the bottom edges of the headrest are not contacting the child's shoulders.
- When lowering the headrest ensure the headrest apron does not bunch up behind the child's neck.

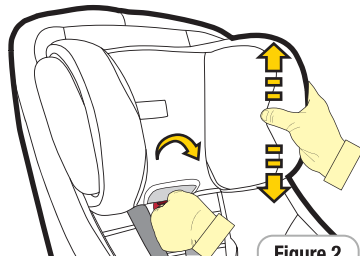

Figure 2

Headrest & Harness Strap Height Adjustment

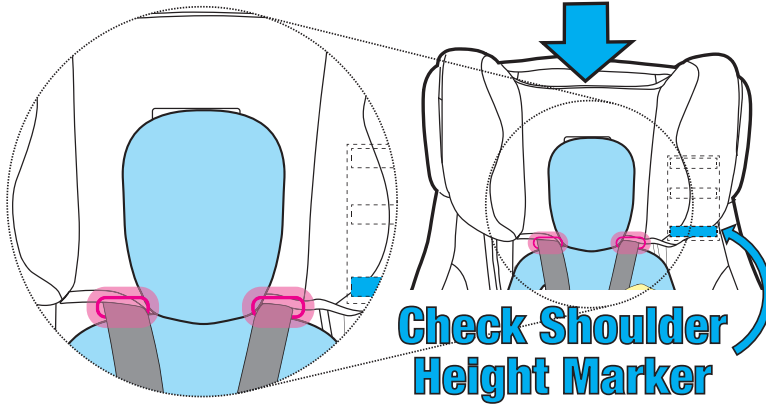

Figure 3



IMPORTANT

ENSURE THE HARNESS STRAPS ARE ALWAYS
THREADED THROUGH THE HEADREST.

Correct fitment of the harness is very important as it restrains the child in the restraint. The harness must fit firmly around the upper torso of the child and be positioned to ensure the child's arms and legs are free.

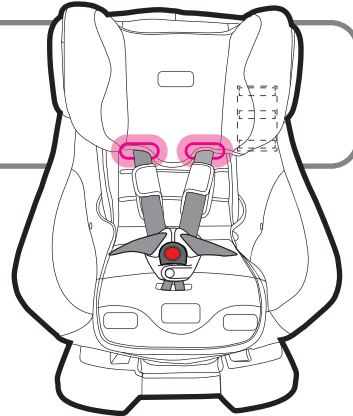

IMPORTANT

- IF THE CHILD'S SHOULDERS TOUCH THE BOTTOM EDGES OF THE HEADREST SIDE WINGS, RAISE THE HEADREST TO THE NEXT HEADREST POSITION.
- THIS CHILD RESTRAINT DOES NOT REQUIRE THE STRAPS TO BE DISCONNECTED TO ADJUST THEIR HEIGHT, ONLY THE HEADREST NEEDS TO BE MOVED TO ADJUST THE SHOULDER STRAP POSITIONS.

Buckle Height Adjustment

The buckle is supplied in a shortened position, if you want to alter the buckle height the following steps are required.

- Step 1:** Lift the buckle and determine the required buckle height (refer Figure 1).
- Step 2:** To alter the buckle height
- Turn the Child Restraint upside down, to access from the bottom (refer Figure 2).
- Step 3:** Remove the screw and lift the 3 bar plate with the adjustable strap (refer Figure 2 and 3).
- Step 4:** Rethread the webbing.
- To shorten the buckle 'Pull' excess webbing through the 3 bar plate.
 - To lengthen the buckle 'Push' excess webbing through the 3 bar plate.

Note: Do not shorten the buckle strap beyond the red stitched line on the strap.



Note: When shortening the buckle ensure the buckle tongues have clearance above the upper thigh (refer page 29).



- Step 5:** Replace the 3 bar plate, and screw into position.
- Step 6:** Turn seat back to upright position & recheck buckle height (refer Figure 4).

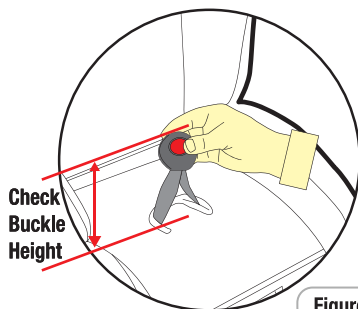

Figure 1

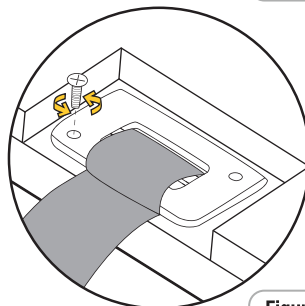

Figure 2

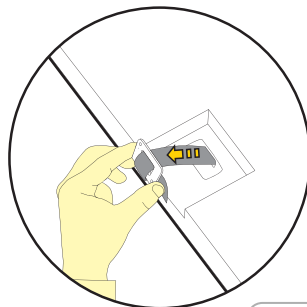

Figure 3

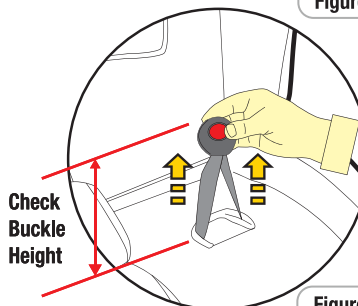

Figure 4

ISOFIX Compatible Restraint

Infant Seat

Rearward Facing

ISOFIX Lower Anchorages

Newer vehicles have one or more seating positions with ISOFIX anchorages. If the vehicle is equipped with ISOFIX anchorage, the lower anchor points may be visible at the vehicle seat bight. If not visible, they may be marked with this symbol.



ISOFIX



See your vehicle owner's manual for exact locations, anchor identification, and requirements for use with a child restraint.

Check vehicle owner's manual for vehicle top tether anchor locations. They may be identified using one of the anchor symbols as shown.



IMPORTANT

ONLY use flexible LAC straps on the child restraint in a seating position recommended by vehicle manufacturer.

This restraint uses Flexible Lower Anchorage Connector Straps. Flexible connectors: A pair of flexible straps with connectors are located at the base of the child restraint which connect to the vehicle's ISOFIX low anchorages. The flexible connectors are then adjusted to secure the child restraint firmly to the vehicle. The top tether strap must be anchored to the vehicle. The vehicle seatbelt will not be required when the flexible connectors are being used.

ISOFIX low anchorages are built in to the vehicle at the time of manufacture, if the vehicle manufacturer chooses to provide them. The number of ISOFIX low anchorages will depend on the design of the vehicle. Generally, ISOFIX low anchorages are located on the two outer seating positions in the second row, and not in the middle seating position.

If you wish to use the middle seating position in the second row, you may still fit an ISOFIX compatible child restraint by using the vehicle seatbelt and top tether strap.

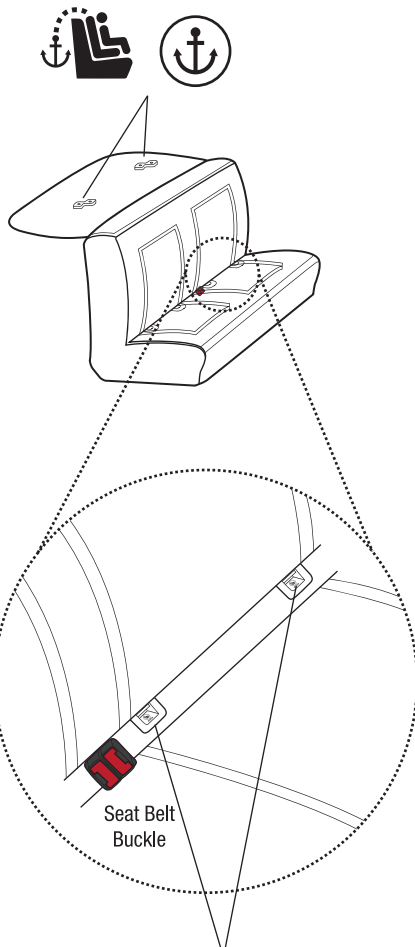

ISOFIX



ISOFIX Compatible Restraint

Infant Seat

Rearward Facing

Accessing the Flexible ISOFIX Lower Anchorage Connectors (LAC)



IMPORTANT

The straps for the flexible ISOFIX Lower Anchorage Connectors (LAC) are stored in a compartment beneath the seat cover.

Step 1: Remove the insert/s to access the seat cover (refer Figure 1).

Step 2: Fold the cover and padding forward (refer Figure 2).

Step 3: Open the ISOFIX storage and remove the LAC strap (refer Figure 3).

Step 4: Pass the LAC strap out through the seat belt path opening. Ensure the flexible LAC straps are laying flat on the plastic shell (refer Figure 4).

Step 5: Close Storage Lid.

Step 6: Repeat steps 3 to 5 for other side. Ensure that there are no twist in the flexible LAC straps.

Step 7: Fold the padding and cover back in place (refer Figure 5).

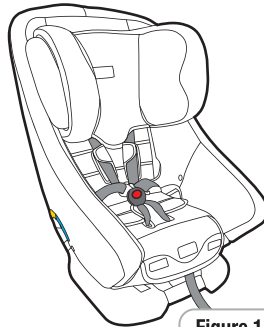

Figure 1

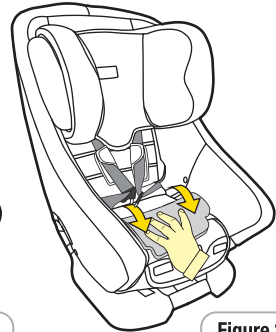

Figure 2

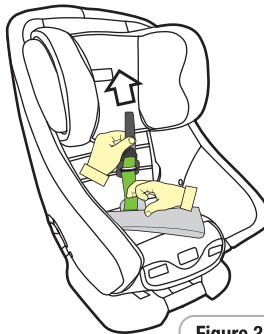

Figure 3

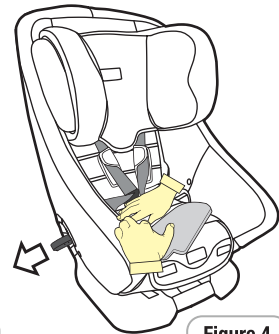
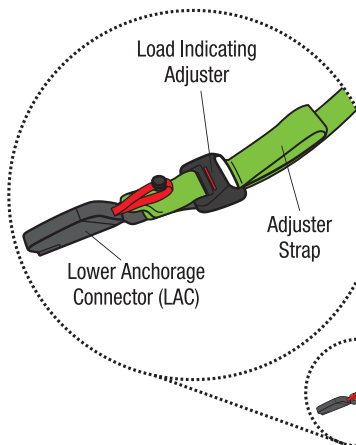

Figure 4



Top Tether Strap

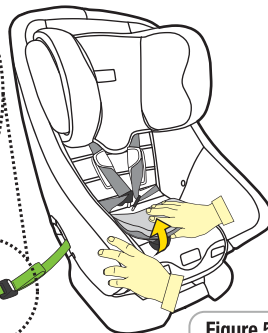

Figure 5

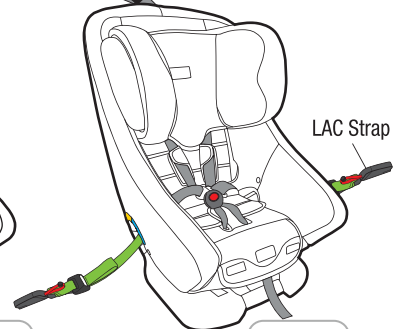

Figure 6

Flexible Lower Anchorage Connector Straps

ISOFIX Compatible Restraint

Infant Seat

Rearward Facing

Installing using Flexible ISOFIX Lower Anchorage Connectors (LAC)

Rearward facing mode

- Step 1:** Fully recline the restraint.
- Step 2:** Swing the Recline Section forward (refer Figure 1).

Install the restraint on the vehicle seat

- Step 1:** Locate the ISOFIX lower anchorage points (refer to page 21).
- Step 2:** Insert the flexible LAC into the ISOFIX lower anchorage point. You may need to 'PUSH' into the seat bite where the ISOFIX symbols indicate. Give a 'PULL' to check for positive engagement (refer Figure 2).
- Step 3:** Push down on the restraint (with knee or hand). Remove all slack from the LAC straps by pulling the adjuster strap firmly. The **GREEN** indication is activated (refer Figure 3 & 4).
- Step 4:** Repeat for both sides of the restraint.

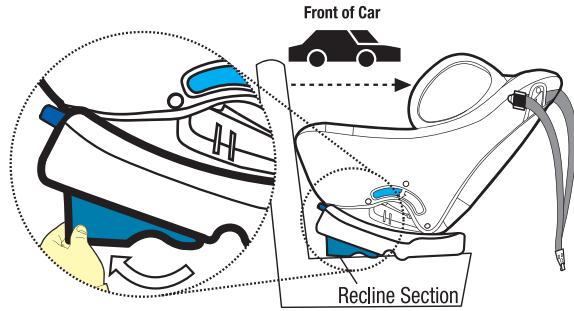

Recline Section (Swing Forward) & child restraint fully reclined.

Figure 1

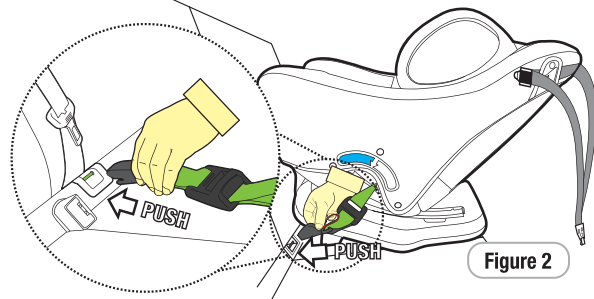

Figure 2

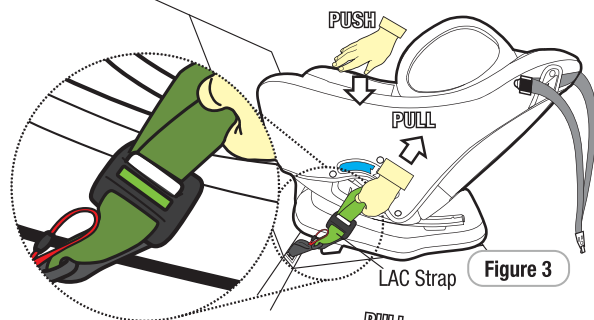

Figure 3

REMOVE ALL SLACK FROM LAC STRAP

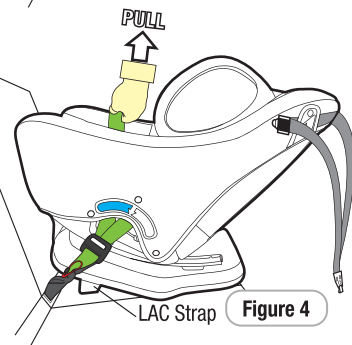

Figure 4

ISOFIX Compatible Restraint

Infant Seat

Rearward Facing

Installing using Flexible ISOFIX Lower Anchorage Connectors (LAC)

Note: If no upper anchorage fitting is available refer to pages 64-65.

Step 5: Locate the adjuster at the side of the restraint and secure using the top tether strap guide (refer Figure 5 & 6).

Step 6: Hook the attachment clip to the upper anchor fitting (refer Figure 7).

Ensure there are no twists in the top tether strap.

IMPORTANT

- The purchaser should check the measurements between the front of the seat back of the rear seat and all front seats in the car in which the child restraint is intended to be used, to ensure that the space is sufficient.
- Care and attention should be given to sufficient ventilation and shading of the baby.
Always secure the loose end of the top tether strap to prevent it hanging out of the car or being accessible by the child.

IMPORTANT

For removal of LAC straps from vehicle 'PULL' the red strap to detach from anchorage point and store in the compartment beneath the seat.

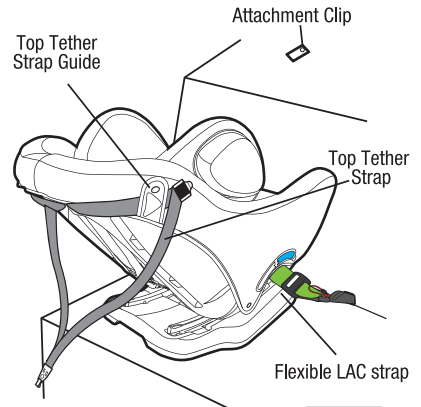

Figure 5

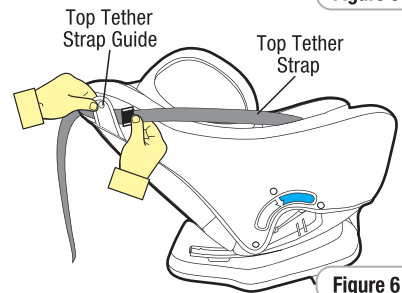

Figure 6

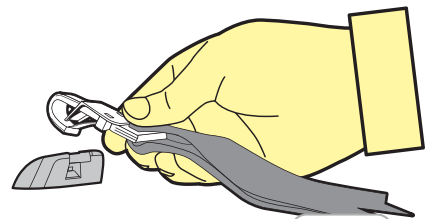

Figure 7

ISOFIX Compatible Restraint

Infant Seat

Rearward Facing

Installing using Flexible ISOFIX Lower Anchorage Connectors (LAC)

Step 7: Pull to tighten to remove all the slack, from the upper anchorage strap. Do not overtighten as this could cause the restraint to lift off the vehicle seat (refer to Figure 8).

IMPORTANT

- Tighten till slack is removed.
- In certain vehicles an extension strap may be needed.
- Do not overtighten top tether strap.
- Ensure top tether strap is passed through the top tether strap guide.

Step 8: Store any excess webbing, from the top tether strap, in the storage pocket provided on the restraint (refer Figure 9).

NOTE

FOLLOWING THE INSTALLATION OF THE CHILD RESTRAINT A SMALL AMOUNT OF MOVEMENT IS DEEMED ACCEPTABLE.

CAUTION: CHILDREN CAN BE INJURED OR RESTRAINTS AND TOP TETHER STRAP DAMAGED BY UNSECURED CARGO IN A COLLISION. SECURE OR REMOVE HAZARDOUS CARGO BEFORE USING THIS CHILD RESTRAINT.

Always secure the loose end of the top tether strap to prevent it hanging out of the car or being accessible by the child.

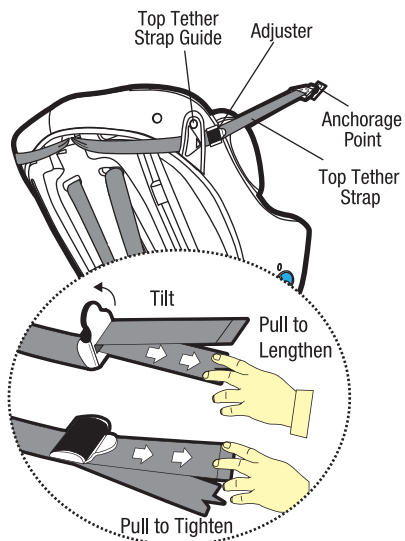

Figure 8

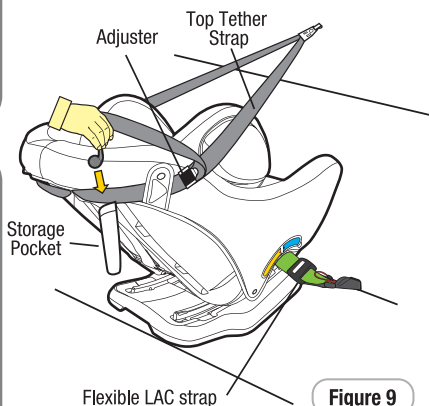

Figure 9

Installation

Infant Seat

Rearward Facing

Installing Using Vehicle Seatbelts

Step 1: Place the child restraint on the vehicle seat. Ensure recline section is swung forward and the restraint is fully reclined with the restraint directly in line with anchorage point.

Step 2: Make sure top tether strap is as in illustration (Figures 1 and 2) i.e. positioned around restraint back.



IMPORTANT

Ensure that you use the **REARWARD-FACING BELT PATH** identified by the following label.

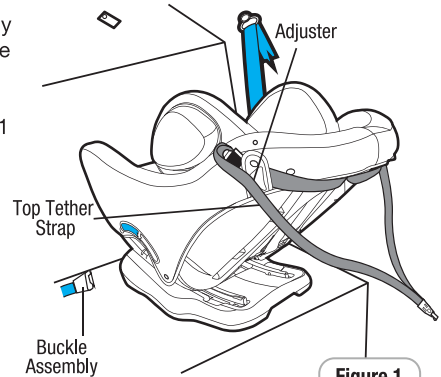
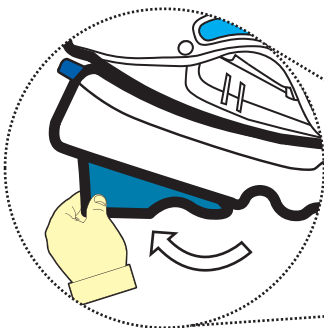

Figure 1

REARWARD FACING BELT PATH



Recline Section (Swung Forward) & child restraint fully reclined.

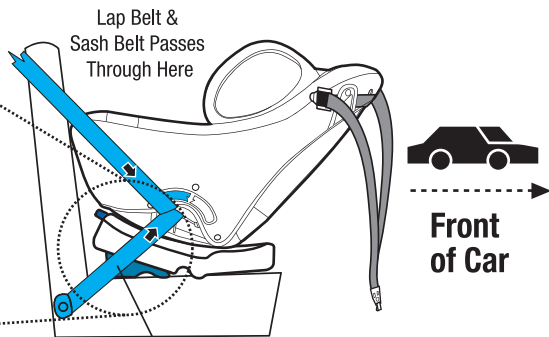

Figure 2

Step 3: Feed adult lap or lap/sash belt through the belt path opening, ensure the seat belt is under the cover & between the layer of foam and the plastic restraint base.

Engage the buckle and tongue assembly (listen for a **“CLICK”**). Check the buckle engagement with a gentle pull.

Installation

Infant Seat

Rearward Facing

Installing Using Vehicle Seatbelts

Step 4: Push down on the base of the restraint (with knee or hand) whilst pulling the sash section of the vehicle belt firmly up in direction of the blue arrow in Figure 4. (This will tighten the lap belt across the restraint base).

NOTE: Ensure the belts are under foam padding

Whilst continuing to pull the sash section up, attach the **Safe Grip** red belt clamp on the sash section **ONLY**, as close as possible above the buckle tongue assembly. (Refer to Figure 5 and Instruction for installing the **Safe Grip** red clamp below)

Step 5: Ensure the excess slack in the sash belt, is fed back towards the seat belt.

Ensure there are no twists in the seatbelt.

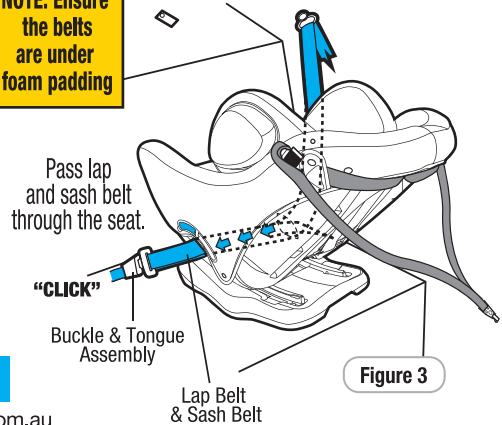

Safe Grip (If Supplied)

*Can be purchased separately visit www.securesafe.com.au

SAFE GRIP BELT CLAMP

The **Safe Grip** (red belt clamp) **locks the lap belt** to ensure a firm installation, and avoids slack in the lap belt.

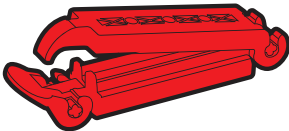

To install the **Safe Grip** (red belt clamp), open it and clamp the “sash section” **ONLY** of the vehicle seat belt by closing the barrel section of the red belt clamp in the direction of arrow 1 in Figure 5 and then locking with the toggle section by pushing in the direction of arrow 2 in Figure 5 when the **Safe Grip** (red belt clamp) is secured in place, the lap section is now tightly holding your child restraint in place, independent of the sash section. The **Safe Grip** (red belt clamp) must be removed when the child restraint is not installed to allow other users to use the seat belt as a lap/sash seat belt. Always keep the **Safe Grip** (red belt clamp) in pocket provided when not in use.

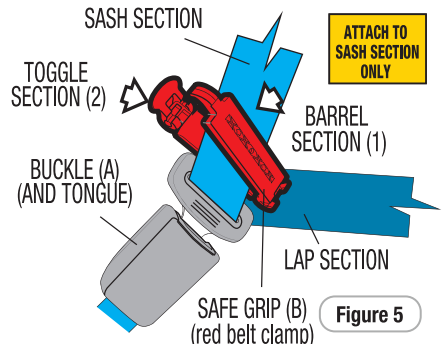
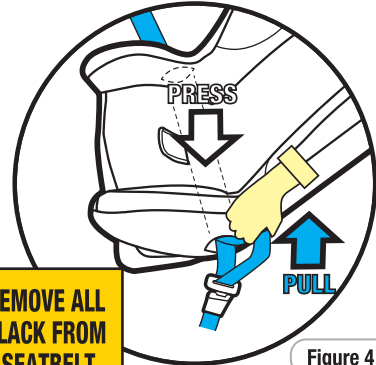

NOTE: Do not place the **Safe Grip** (red belt clamp) around both the lap and sash sections of the belt. This could cause the **Safe Grip** (red belt clamp) to break.

Installation

Infant Seat

Rearward Facing

Installing Using Vehicle Seatbelts

Note: If no upper anchorage fitting is available refer to pages 64–65.

Step 6: Locate the adjuster at the side of the restraint and secure using the top tether strap guide (refer Figure 6 & 7).

Step 7: Hook the attachment clip to the upper anchor fitting (refer Figure 8).

Ensure there are no twists in the top tether strap.

IMPORTANT

- The purchaser should check the measurements between the front of the seat back of the rear seat and all front seats in the car in which the child restraint is intended to be used, to ensure that the space is sufficient.
- Care and attention should be given to sufficient ventilation and shading of the baby.
Always secure the loose end of the top tether strap to prevent it hanging out of the car or being accessible by the child.

WARNING

- DO NOT USE REAR FACING CHILD RESTRAINT WHERE AN AIRBAG IS FITTED IN FRONT OF THE SEATING POSITION.
- Fit the restraint firmly to the car seat.
- THIS TETHER STRAP MUST ALWAYS BE FITTED WHEN THE CHILD RESTRAINT IS USED IN A VEHICLE.

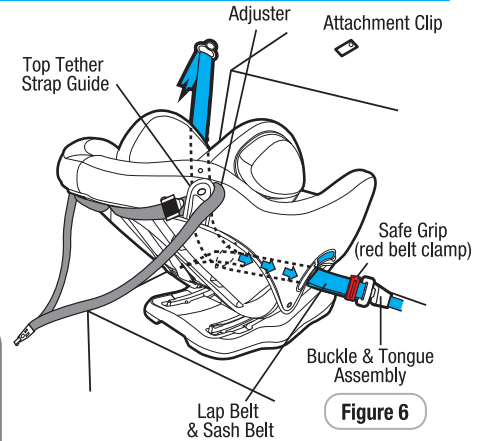

Figure 6

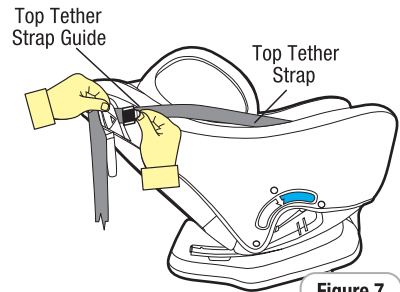

Figure 7

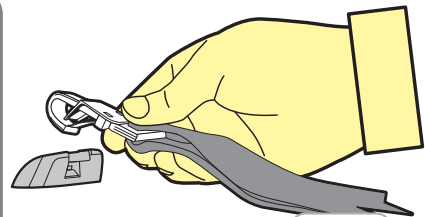

Figure 8

Installation

Infant Seat

Rearward Facing

Installing Using Vehicle Seatbelts

Step 8: Pull to tighten to remove all the slack, from the upper anchorage strap. Do not overtighten as this could cause the restraint to lift off the vehicle seat (refer Figure 9).

IMPORTANT

- Tighten till slack is removed.
- In certain vehicles an extension strap may be needed.
- Do not overtighten top tether strap.
- Ensure top tether strap is passed through the top tether strap guide.

NOTE

FOLLOWING THE INSTALLATION OF THE CHILD RESTRAINT A SMALL AMOUNT OF MOVEMENT IS DEEMED ACCEPTABLE.

CAUTION: CHILDREN CAN BE INJURED OR RESTRAINTS AND TOP TETHER STRAP DAMAGED BY UNSECURED CARGO IN A COLLISION. SECURE OR REMOVE HAZARDOUS CARGO BEFORE USING THIS CHILD RESTRAINT.

Always secure the loose end of the top tether strap to prevent it hanging out of the car or being accessible by the child.

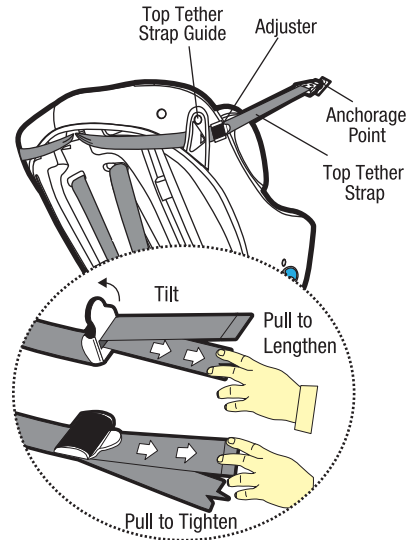

Figure 9

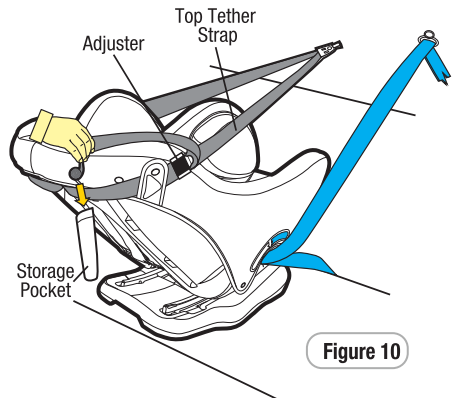

Figure 10

Tether Storage

Store any excess webbing, from the top tether strap, in the storage pocket provided on the restraint (refer Figure 10).

Using Inbuilt Harness

Step 1: Ensure the restraint has been set up and installed as per “Setup” and “Installation” (refer page 13-29).

Step 2: To lengthen the harness “LIFT” the harness adjuster (refer Figure 2) whilst grasping both shoulder harness straps and pulling. Ensure shoulder straps are pulled equally on each side.



WARNING

To ensure infant's back is evenly supported, do not put more than one nappy on the baby and make sure the nappy is not thickly folded at the back.

Step 3: Place the child in the restraint with legs either side of the buckle, place the harness over the shoulders and hips (refer Figure 3).

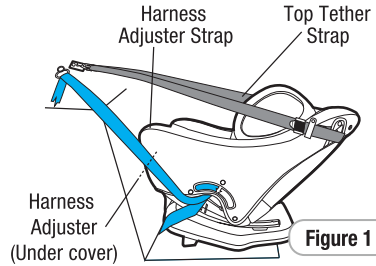
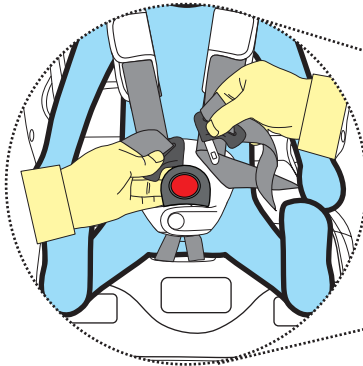

Figure 1

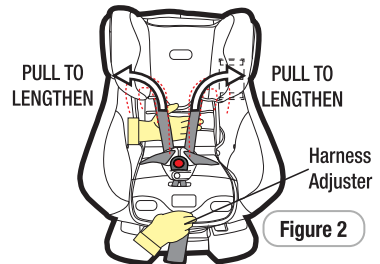

Figure 2

“LIFT” TO LENGTHEN

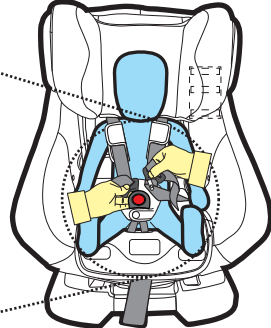

Figure 3

NOTE: To change the buckle height refer to “Buckle Height Adjustment” (refer page 20).



IMPORTANT

KEEP BUCKLE LOW AS POSSIBLE

Always ensure buckle has clearance from the upper thighs (see indicated area Figure 4).

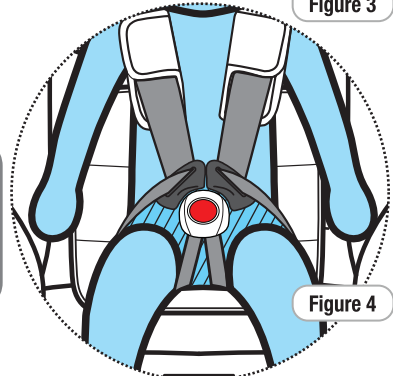

Figure 4

Using Inbuilt Harness

Step 4: Insert either tongue into the buckle followed by the other tongue until a **“CLICK”** is heard. Should the second tongue not insert, press the red button and reinsert the tongues. Ensure secure engagement by pulling the harness strap (refer Figure 5).

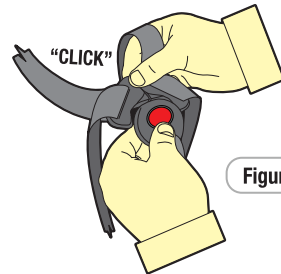
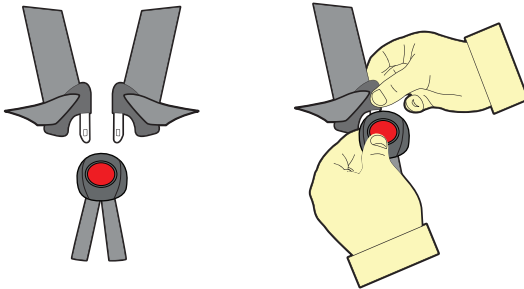

Figure 5



IMPORTANT

If no “Click” can be heard or a secure engagement cannot be achieved refer to “Cleaning Buckle Harness” page 57.

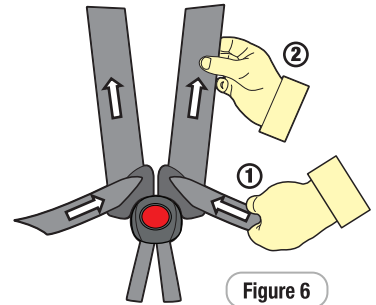

Figure 6

Step 5: Remove all of the slack for the harness lap straps by pulling shoulder straps (refer Figure 6), then pull the harness adjustment strap to adjust harness to a comfortable but firm fit (refer Figure 6 & 7).



WARNINGS

- **DO NOT LEAVE CHILDREN UNATTENDED IN THE CAR.**
- Fit the harness firmly to the child.
- **A LOOSE HARNESS IS DANGEROUS.**

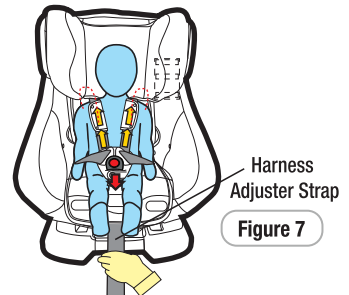

Figure 7

PULL TO TIGHTEN

REMOVE ALL SLACK FROM HARNESS

Using Inbuilt Harness

IMPORTANT

- The Padded Insert/s (if fitted) are designed to provide extra support and comfort for small babies. Discontinue use when the insert is a tight fit or creates discomfort for larger babies/children.
- Always adjust the height of the shoulder straps as the child grows.

NOTE: If top tether strap has been loosened to allow easier placing of the baby in the restraint, tighten the upper anchorage strap so it has no slack in it. **DO NOT TIGHTEN EXCESSIVELY.**

Step 6: Check the harness tightness by the **PINCH TEST**, this is achieved by pinching the harness webbing at the shoulders (refer Figure 8).

- If you can pinch the harness strap, tighten more.
- If your fingers slip off, then the harness is tight enough.

If required repeat Step 5.

Step 7: Pull to tighten to remove all the slack, from the upper anchorage strap. Do not overtighten as this could cause the restraint to lift off the vehicle seat (refer Figure 9).

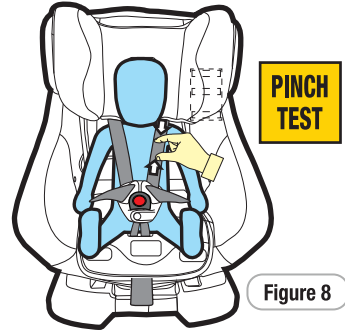

Figure 8

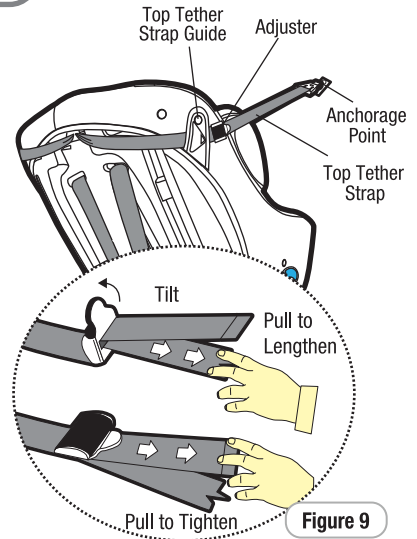

Figure 9

Tether Storage

Store any excess webbing, from the top tether strap, in the storage pocket provided on the restraint (refer Figure 10). Otherwise secure to the top tether by using the velcro connectors.

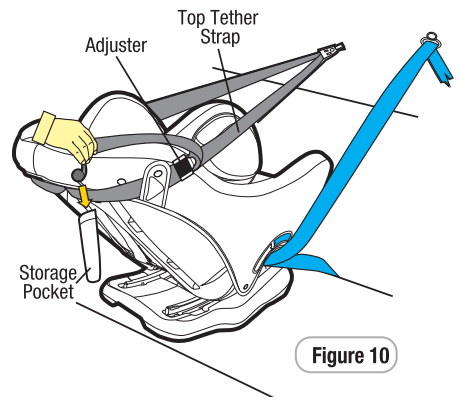

Figure 10

To Release Infant

Step 1: To release your child from the restraint simply press the red button on the harness buckle and carefully remove your child from the restraint (refer Figure 1).

NOTE: If top tether strap has been loosened to allow easier placing of the baby in the restraint, always retighten the top tether strap so it has no slack in it. **DO NOT OVERTIGHTEN.**

For Ease Of Use

No need to disconnect the Upper Anchorage Strap.

To **access** your baby simply;

- Loosen upper anchorage strap (refer Figure 2).
- Lower strap out of way (refer Figure 3).

Reverse procedure when reseating the baby.

WARNING

- Always use a lap or lap-sash seat belt and Top Tether strap to attach the child restraint to the vehicle.
- Do not use the restraint without the Top Tether strap correctly attached and adjusted.
- Do not use on any vehicle seat which faces sideways or rearwards.
- **IF AN AIRBAG IS FITTED IN THE SEATING POSITION WHERE THE CHILD RESTRAINT IS TO BE FITTED, FOLLOW THE VEHICLE MANUFACTURER'S WARNINGS AND INSTRUCTIONS.**
- Do not use the restraint if the buckle is sluggish or does not provide an audible "Click" refer to "Cleaning Instructions" on page 57.
- Always keep adjuster within this region (refer Figure 2).

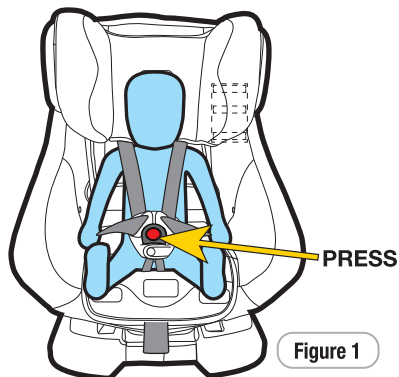

Figure 1

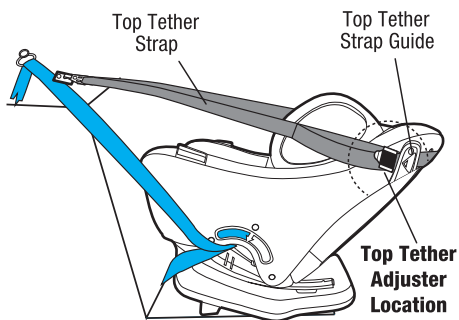

Figure 2

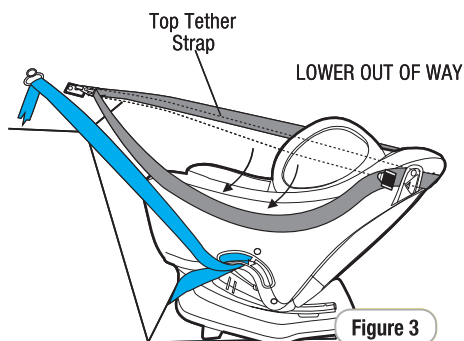

Figure 3

THE SUITABILITY OF THE CHILD RESTRAINT TO GROUPS OF CHILDREN

TYPE A4

To be used only in a rearward-facing position until the infant's shoulders either reach the lower shoulder height marker (approximately 12 months of age) or reach the middle height marker (approx 2 to 3 years of age).

TYPE B

Then to be used in a forward-facing position until the child's shoulders reach the upper shoulder height marker (approximately 4 years of age).

Continue to use this child restraint until the child shoulders reaches this limit.

Do not use forward-facing until child's shoulders are above the lower shoulder height marker.

Infants are at risk of serious injury if they face forward too early.

Children are at risk of serious injury if they move to booster seats too early.

Children who have outgrown this restraint are safest in a larger child restraint with an in-built harness or a booster seat until their shoulders reach the upper shoulder height marker of the restraint.

TO BE USED WITH A LAP-SASH/LAP-ONLY SEAT BELT OR ISOFIX LOW ANCHORAGES IN THE BACK OF MOST CARS WITH FORWARD FACING SEATS.

The use of child restraints in the front seat may be restricted for children of specific ages by local legislation. Please check with your local Department of Transport for the specific seating locations of children using child restraints for their given ages.



IMPORTANT

- For a vehicle without a fixed parcel shelf an extension strap(s) may be needed. If so ring 1300 92 4632 (AU) or 067 590 870 (NZ) for nearest supply location (refer page 60).
- Seatbelt extenders are not recommended to be used if the seatbelt is not long enough to secure the child restraint. If seatbelts are too short then advice should be sought from a child restraint fitter and their recommendation be considered before using a seatbelt extender.

Shoulder Height Marker

Child Car Seat

Forward Facing

Smaller Child (Using Inbuilt Harness)

Once the child's shoulders reach the lower shoulder height marker the restraint can either

- Remain **REARWARD FACING** until the middle shoulder height marker is reached (approx 2 to 3 years) or
- Change to **FORWARD FACING** until the upper shoulder height marker is reached (approx 4 years old).

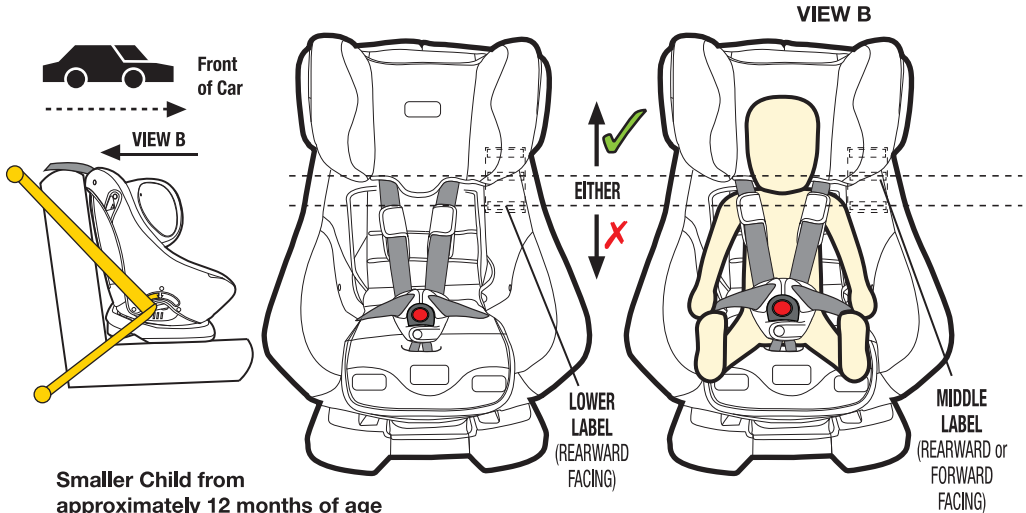

Smaller Child from approximately 12 months of age

Do not use as a forward-facing child restraint until the child's shoulders are **ABOVE** the Lower shoulder height marker (Lower label).



LOWER LABEL
When the child's shoulders reach the lower shoulder height marker, the child restraint **MAY** be turned forward facing. (approximately 12 months of age).

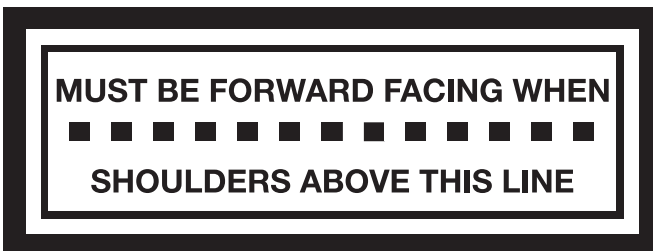

MIDDLE LABEL
When the child's shoulders reach the middle shoulder height marker, the seat **MUST** be turned into the forward facing mode (approximately 30 months of age).

Shoulder Height Marker

Child Car Seat

Forward Facing

Taller Child (Using Inbuilt Harness)

Do not continue to use the restraint if the child's shoulder are above the Upper Label.

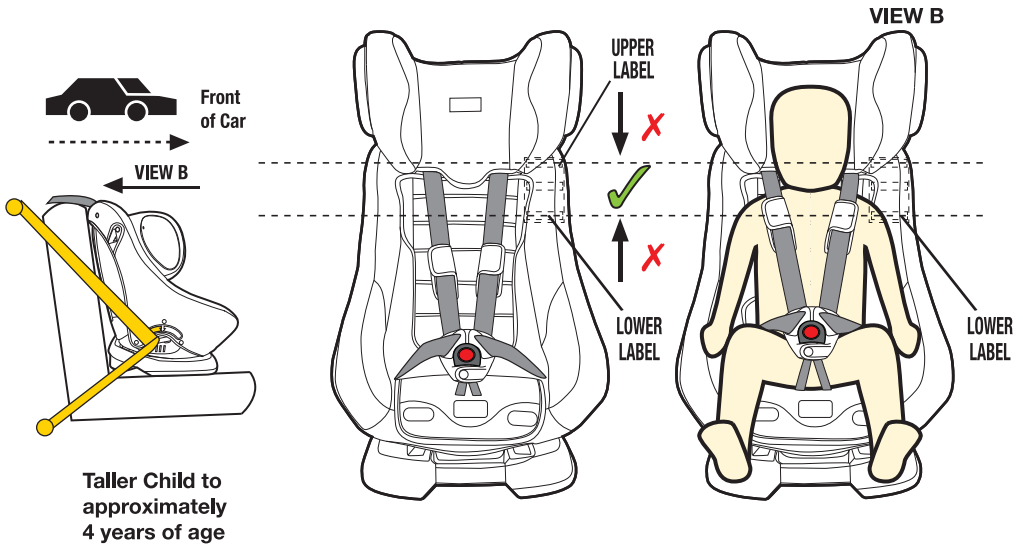

Continue to use this forward-facing child restraint until the child's shoulders **REACH** the Upper shoulder height marker (Upper Label).

UPPER LABEL (Forward-Facing)

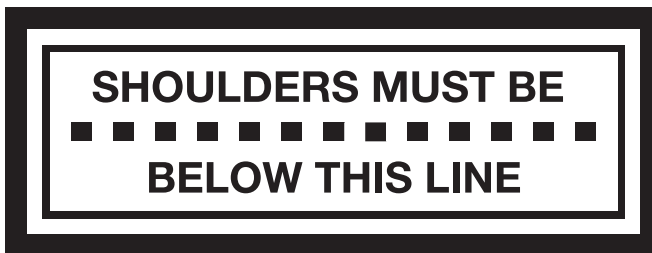

Children are at risk of serious injury if they move to booster seats too early.

Children that have outgrown the forward-facing child restraint are safest in a booster seat until their shoulders reach the upper shoulder height marker of the booster seat.

The child restraint is unsuitable for the occupant when the shoulders are above the upper marker. The child needs to be moved into the next form of child restraint eg. Type G, Type E booster seat or Type F booster seat when they reach the top shoulder height marker.

For the next child restraint refer to the "Restraint Guide" on page 7 and 38.

Model CS8713

Child Car Seat

Forward Facing

Shoulder height markers may be hidden under the headrest

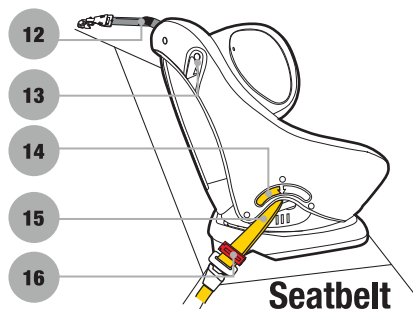
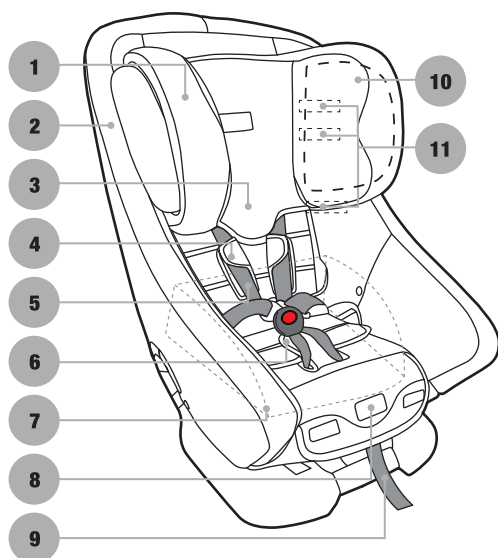

Seatbelt

ISOFIX
Compatible

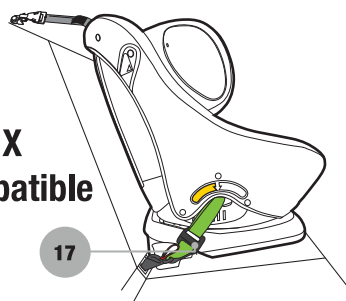

1. Adjustable Headrest (with Protect Plus)
2. Comfort Covers
3. "TrueFit" Headrest + Harness adjustment system
4. Shoulder Pads
5. Harness Straps
6. Buckle Pad
7. Padded Insert (if fitted)
8. Harness Adjuster
9. Harness Adjustment Strap
10. Active Air Pads (if fitted)
11. Shoulder Height Markers
12. Top Tether Assembly
 - Tether Strap
 - Adjuster
 - Attachment Clip
 - Anchor Fitting + Attachment Hardware
13. Top Tether Guide
14. "FORWARD-FACING SEAT BELT PATH" Marker (each side of restraint - coloured yellow)
15. Vehicle Seat belt
16. Safe Grip Red Belt Clamp (if supplied with restraint)
17. ISOFIX Compatible Lower Attachment Connectors (LAC)

NOTE: Padded inserts can vary according to model. For detailed description and method of attachment for padded accessories refer to Accessories on page 61.

Next Restraint

Child Car Seat

Forward Facing

Next Type of Restraint

Refer to the 'RESTRAINT GUIDE' for the selection for the most appropriate next restraint (refer page 7). When the child has outgrown the child restraint, then you can use either of the following;

- **Convertible booster seat** - Type (B/E) internal harness until approx 4 years old and then as a booster seat with vehicle lap-sash seatbelt.
- **Booster seat** - Larger Type (E) or Type (F) booster seat with vehicle lap-sash seatbelt.
- **Child Car Seat** - Type (G) harnessed child restraint suitable approx 6 months to 8 years.

For more information Visit:
www.seuresafe.com.au



Figure 1



Figure 2



Figure 3

Selection of Appropriate Padding Combinations

Step 1: Determine whether your child requires the additional padding provided with this restraint, to ensure a safe and snug fit in the restraint. Refer to Page 7 for suggested padding combinations.

Converting to Child Car Seat

Reclined Position

Step 1: Ensure the recline section is swung rearward (refer Figure 1).

Step 2: At the front of the restraint is a blue* lever. Pull the blue* lever forward and slide the restraint to obtain the desired upright or reclined angle.

*Colour may vary.

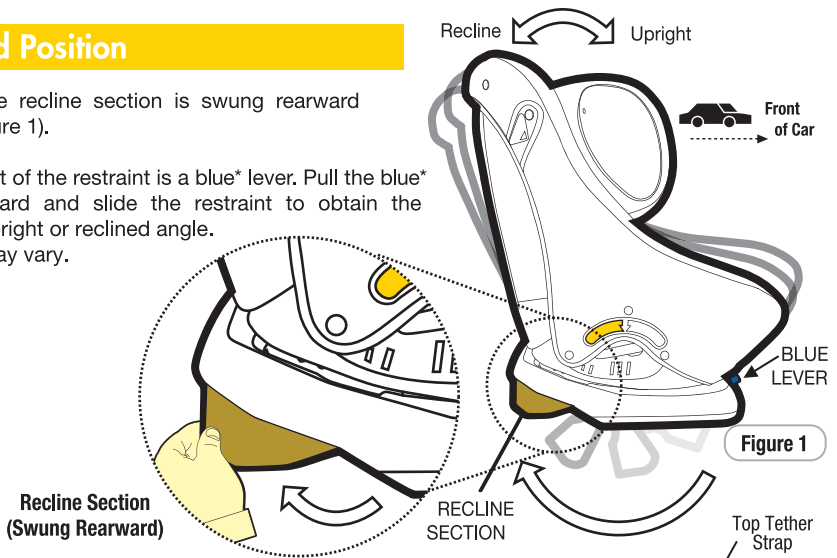

IMPORTANT

Refer to the shoulder height labels (As shown on pages 35 and 36).

Adjuster Assembly Location

Forward Facing (Type B)

Step 1: Pull excess strap through the top section ① whilst feeding the adjuster section ② towards the restraint (refer Figure 2).

Step 2: Continue to shorten until you have reached the desired position at the rear of the restraint (refer Figure 3).

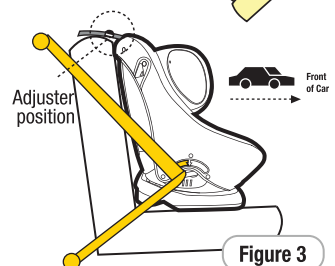
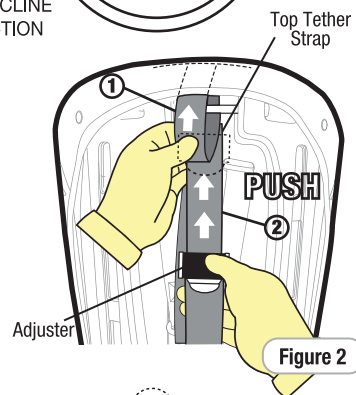

Shoulder Height

Zone

The child's shoulder region.

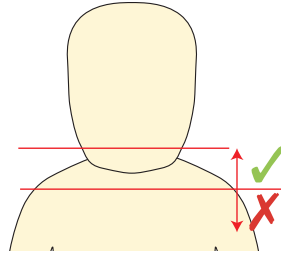

Slot Position

Nearest to the child's shoulders, but not more than 25mm below the child's shoulders.

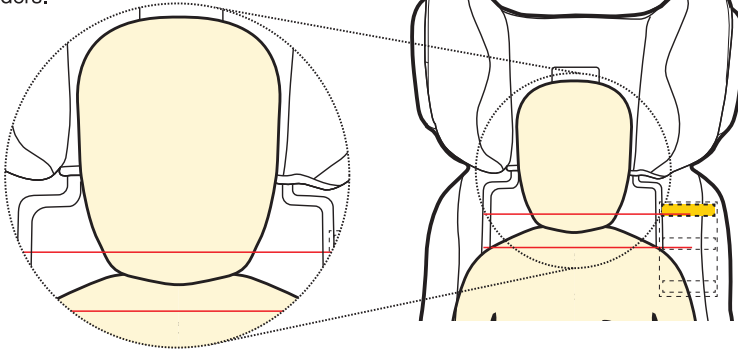

Headrest Position

Position the headrest above the shoulders, to ensure the straps are nearest to but not more than 25mm below the child's shoulders.

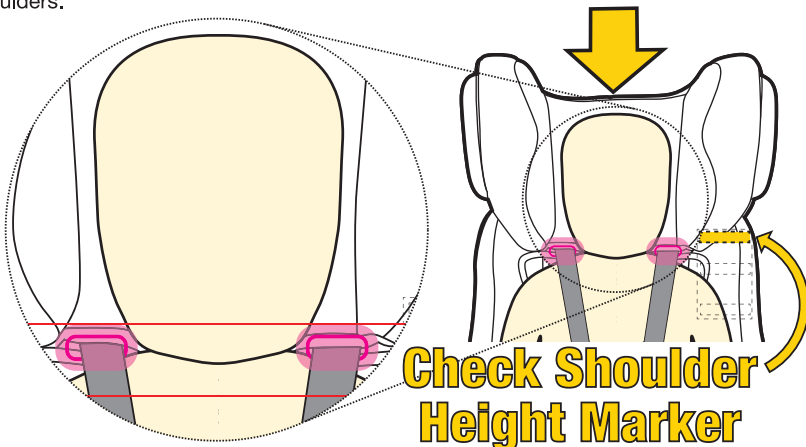

Setup

Child Car Seat

Forward Facing

Shoulder Height

The correct height for the shoulder straps is very important for the optimum performance of the restraint.



IMPORTANT

The shoulder straps must be positioned nearest to the child's shoulders, but not more than 25mm below the child's shoulders.

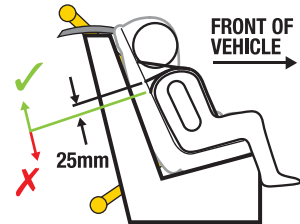

There is only one set of slots so the seat will always have the shoulder straps in place once the headrest is positioned correctly, just above the child's shoulders.

Headrest & Harness Strap Height Adjustment

Step 1: Loosen the harness straps before adjusting the headrest (refer "Using Inbuilt Harness" page 52).

You do not need to remove the restraint from the vehicle to adjust the harness or headrest positions.

Step 2: To adjust the headrest, lift the "TrueFit" flap on the headrest cover. Turn the red "TrueFit" knob clockwise to unlock the headrest (refer Figure 1).

Step 3: Lift up or push down the headrest so that the shoulder strap slots are level with or slightly above your child's shoulders. If the headrest is just above the shoulders then the harness level will be correct (refer Figure 2).

Step 4: Release "TrueFit" knob so that it locks into position. Ensure that it has locked in position by gently pushing down on the headrest.

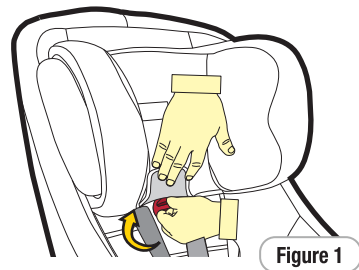

Figure 1

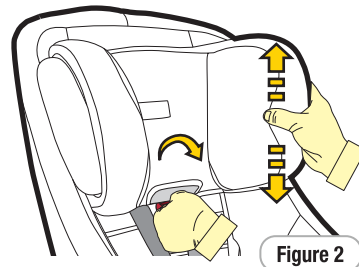

Figure 2



IMPORTANT

- For comfort ensure the bottom edges of the headrest are not contacting the child's shoulders.
- When lowering the headrest ensure the headrest apron does not bunch up behind the child's neck.

Headrest & Harness Strap Height Adjustment

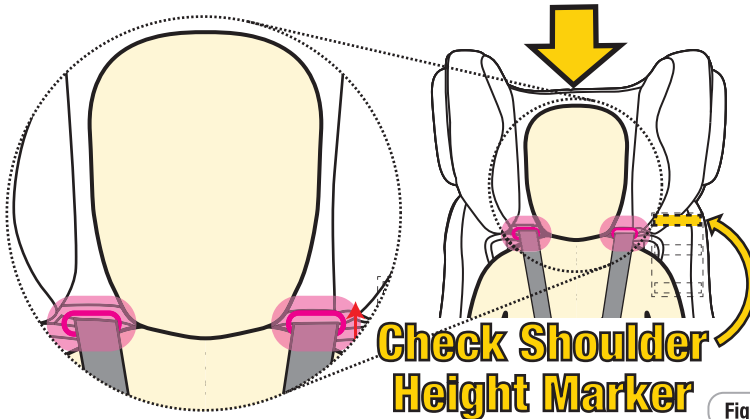

Figure 3



IMPORTANT

ENSURE THE HARNESS STRAPS ARE ALWAYS THREADED THROUGH THE HEADREST.

Correct fitment of the harness is very important as it restrains the child in the restraint. The harness must fit firmly around the upper torso of the child and be positioned to ensure the child's arms and legs are free.

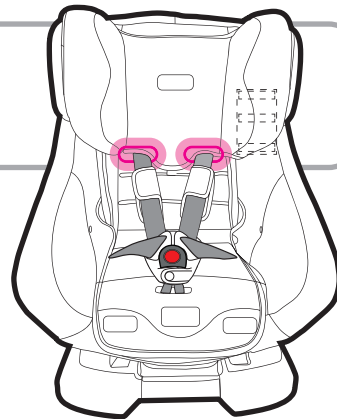

IMPORTANT

- IF THE CHILD'S SHOULDERS TOUCH THE BOTTOM EDGES OF THE HEADREST SIDE WINGS, RAISE THE HEADREST TO THE NEXT HEADREST POSITION.
- THIS CHILD RESTRAINT DOES NOT REQUIRE THE STRAPS TO BE DISCONNECTED TO ADJUST THEIR HEIGHT, ONLY THE HEADREST NEEDS TO BE MOVED TO ADJUST THE SHOULDER STRAP POSITIONS.

Buckle Height Adjustment

The buckle is supplied in a shortened position, if you want to alter the buckle height the following steps are required.

Step 1: Lift the buckle and determine the required buckle height (refer Figure 1).

Step 2: To alter the buckle height
- Turn the Child Restraint upside down, to access from the bottom (refer Figure 2).

Step 3: Remove the screw and lift the 3 bar plate with the adjustable strap (refer Figure 2 and 3).

Step 4: Rethread the webbing.
-To shorten the buckle 'Pull' excess webbing through the 3 bar plate.
-To lengthen the buckle 'Push' excess webbing through the 3 bar plate.

Note: Do not shorten the buckle strap beyond the red stitched line on the strap.

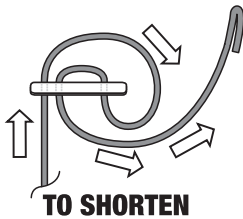

Note: When shortening the buckle ensure the buckle tongues have clearance above the upper thigh (refer page 52).

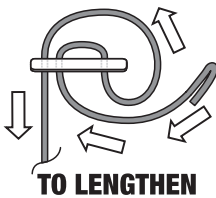

Step 5: Replace the 3 bar plate, and screw into position.

Step 6: Turn seat back to upright position & recheck buckle height (refer Figure 4).

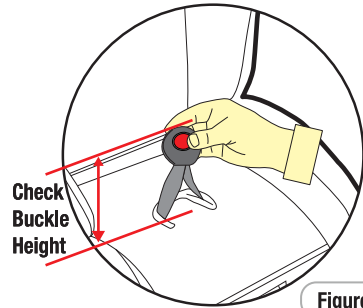

Figure 1

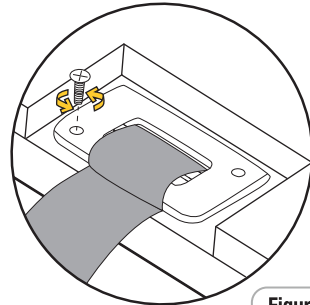

Figure 2

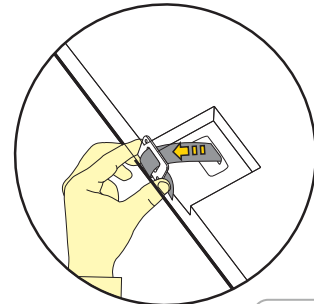

Figure 3

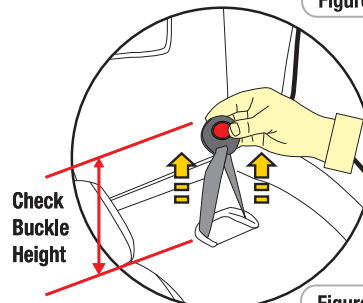

Figure 4

ISOFIX Compatible Restraint

Child Car Seat

Forward Facing

ISOFIX Lower Anchorages

Newer vehicles have one or more seating positions with ISOFIX anchorages. If the vehicle is equipped with ISOFIX anchorage, the lower anchor points may be visible at the vehicle seat bight. If not visible, they may be marked with this symbol.



ISOFIX



See your vehicle owner's manual for exact locations, anchor identification, and requirements for use with a child restraint.

Check vehicle owner's manual for vehicle top tether anchor locations. They may be identified using one of the anchor symbols as shown.



IMPORTANT

ONLY use flexible LAC straps on the child restraint in a seating position recommended by vehicle manufacturer.

This restraint uses Flexible Lower Anchorage Connector Straps. Flexible connectors: A pair of flexible straps with connectors are located at the base of the child restraint which connect to the vehicle's ISOFIX low anchorages. The flexible connectors are then adjusted to secure the child restraint firmly to the vehicle. The top tether strap must be anchored to the vehicle. The vehicle seatbelt will not be required when the flexible connectors are being used.

ISOFIX low anchorages are built in to the vehicle at the time of manufacture, if the vehicle manufacturer chooses to provide them. The number of ISOFIX low anchorages will depend on the design of the vehicle. Generally, ISOFIX low anchorages are located on the two outer seating positions in the second row, and not in the middle seating position.

If you wish to use the middle seating position in the second row, you may still fit an ISOFIX compatible child restraint by using the vehicle seatbelt and top tether strap.

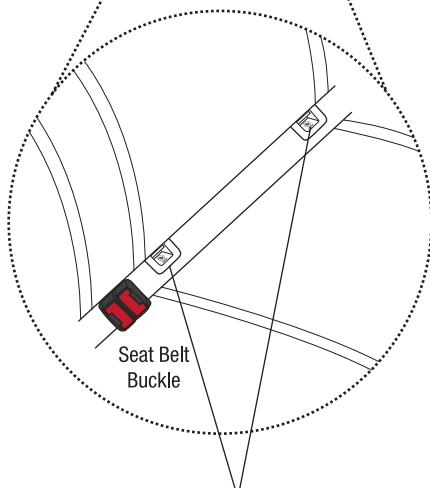
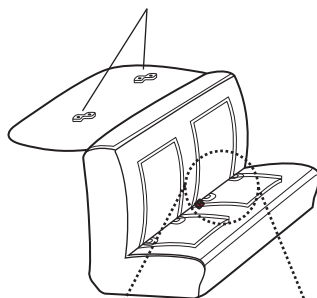

ISOFIX



ISOFIX Compatible Restraint

Child Car Seat

Forward Facing

Accessing the Flexible ISOFIX Lower Anchorage Connectors (LAC)



IMPORTANT

The straps for the flexible ISOFIX Lower Anchorage Connectors (LAC) are stored in a compartment beneath the seat cover.

Step 1: Remove the insert/s to access the seat cover (refer Figure 1).

Step 2: Fold the cover and padding forward (refer Figure 2).

Step 3: Open the ISOFIX storage and remove the LAC strap (refer Figure 3).

Step 4: Pass the LAC strap out through the seat belt path opening. Ensure the flexible LAC straps are laying flat on the plastic shell (refer Figure 4).

Step 5: Close Storage Lid.

Step 6: Repeat steps 3 to 5 for other side. Ensure that there are no twist in the flexible LAC straps

Step 7: Fold the padding and cover back in place (refer Figure 5).

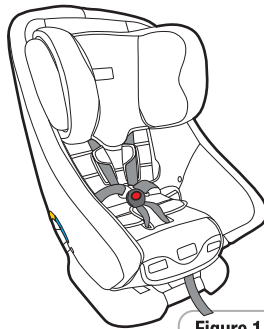

Figure 1

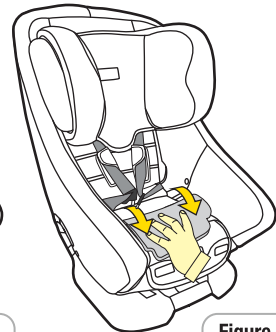

Figure 2

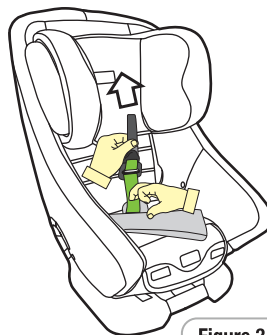

Figure 3

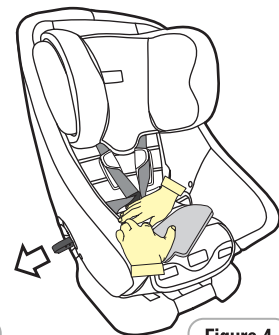

Figure 4

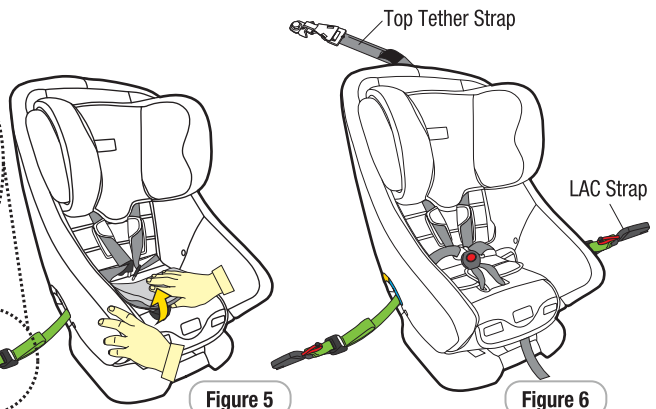
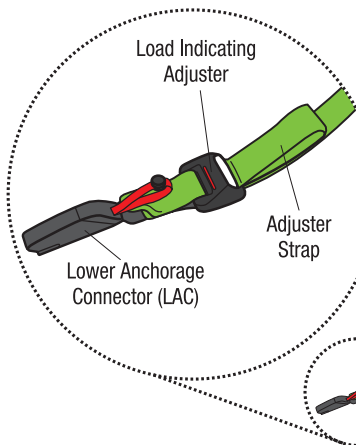

Figure 5

Figure 6

Flexible Lower Anchorage Connector Straps

ISOFIX Compatible Restraint

Child Car Seat

Forward Facing

Installing using flexible ISOFIX Lower Anchorage Connectors (LAC)

Forward facing mode

Step 1: Fully recline the restraint

Step 2: Swing the Recline Section rearward (refer Figure 1).

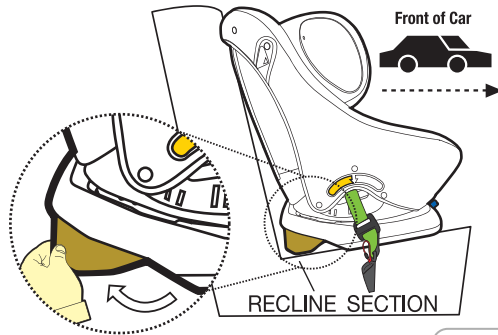

Figure 1

Install the restraint on the vehicle seat

Step 1: Locate the ISOFIX lower anchorage points (refer to page 44).

Step 2: Insert the flexible LAC into the ISOFIX lower anchorage point. You may need to 'PUSH' into the seat bite where the ISOFIX symbols indicate. Give a 'PULL' to check for positive engagement (refer Figure 2).

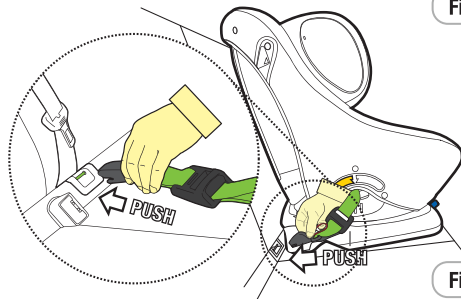

Figure 2

Step 3: Push down on the restraint (with knee or hand). Remove all slack from the LAC straps by pulling the adjuster strap firmly. The **GREEN** indication is activated (refer Figure 3 & 4).

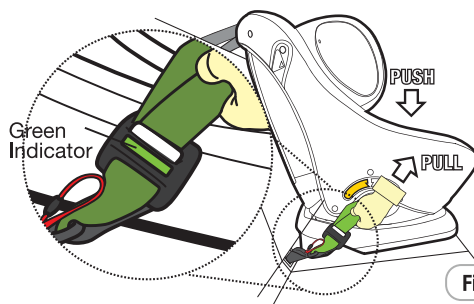

Figure 3

Step 4: Repeat for both sides of the restraint.

**REMOVE ALL SLACK
FROM LAC STRAP**

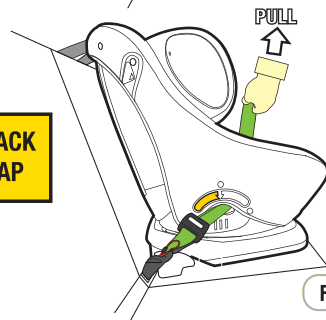

Figure 4

Installing using Flexible ISOFIX Lower Anchorage Connectors (LAC)

Note: If no upper anchorage fitting is available refer to pages 64 & 65.

- Step 5:** Hook the attachment clip to the anchor fitting. **Ensure there are no twists in the top tether strap** (refer to Figure 5).
- Step 6:** Pull to tighten to remove all the slack, from the upper anchorage strap. Create a firm installation by tightening the upper anchorage strap (refer to Figure 6).
- Step 7:** Store any excess webbing, from the top tether strap, in the storage pocket provided on the restraint (refer to Figure 7).

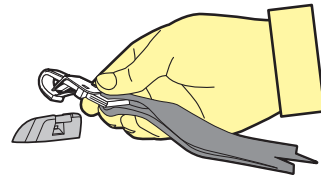

Figure 5

IMPORTANT

For removal of LAC straps from vehicle 'PULL' the red strap to detach from anchorage point and store in the compartment beneath the seat.

NOTE

FOLLOWING THE INSTALLATION OF THE CHILD RESTRAINT A SMALL AMOUNT OF MOVEMENT IS DEEMED ACCEPTABLE.

CAUTION: CHILDREN CAN BE INJURED OR RESTRAINTS AND TOP TETHER STRAP DAMAGED BY UNSECURED CARGO IN A COLLISION. SECURE OR REMOVE HAZARDOUS CARGO BEFORE USING THIS CHILD RESTRAINT.

Always secure the loose end of the top tether strap to prevent it hanging out of the car or being accessible by the child.

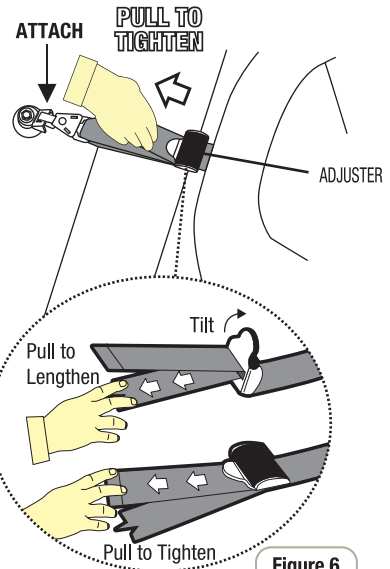

Figure 6

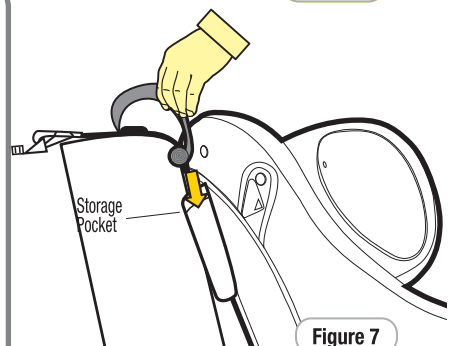

Figure 7

Installation

Child Car Seat

Forward Facing

Installing Using Vehicle Seatbelt

Step 1: Place the restraint in desired upright or reclined position, with the back against the back of the vehicle seat, directly in line with the anchorage point (refer Figure 1).



IMPORTANT

Ensure that you use the
FORWARD-FACING BELT PATH
identified by the following label.

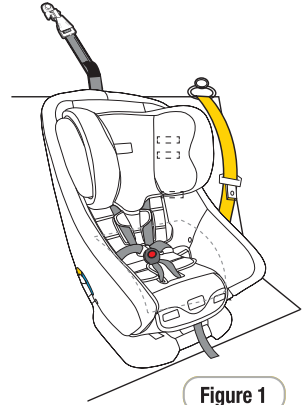

Installation

Child Car Seat

Forward Facing

Installing Using Vehicle Seatbelt

Step 2: Feed adult lap or lap/sash belt through the belt path opening, ensure the seat belt is under the cover & between the layer of foam and the plastic restraint base (refer Figure 2 & 3).

Engage the buckle and tongue assembly (listen for a **“CLICK”**). Check the buckle engagement with a gentle pull.



WARNING

- Always use Top Tether strap to attach the child restraint to the vehicle.
- Do not use the restraint without the Top Tether strap correctly attached and adjusted.
- Do not use on any vehicle seat which faces sideways or rearwards.
- IF AN AIRBAG IS FITTED IN THE SEATING POSITION WHERE THE CHILD RESTRAINT IS TO BE FITTED, FOLLOW THE VEHICLE MANUFACTURER'S WARNINGS AND INSTRUCTIONS.
- Fit the restraint firmly to the car seat.

NOTE: Ensure the belts are under foam padding

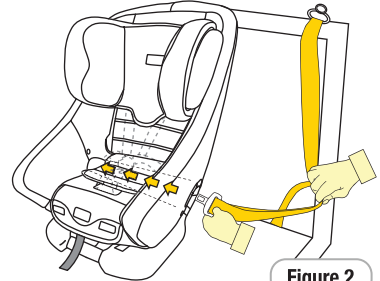

Pass lap and sash belt through the seat.

Figure 2

NOTE: Ensure the belts are under foam padding

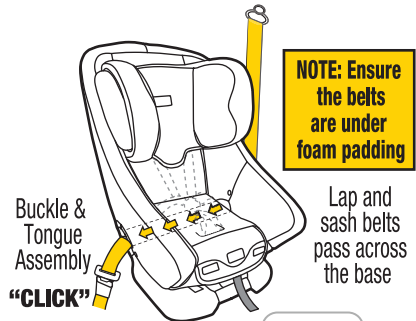

Lap and sash belts pass across the base

Figure 3

Step 3: Push down on the base of the restraint (with knee or hand) whilst pulling the sash section of the vehicle belt firmly up in direction of the yellow arrow in Figure 4. (This will tighten the lap belt across the restraint base).

Whilst continuing to pull the sash section up, attach the **Safe Grip** red belt clamp on the sash section **ONLY** as close as possible above the buckle tongue assembly. (refer to Figure 5 and Instruction for installing the **Safe Grip** red clamp below).

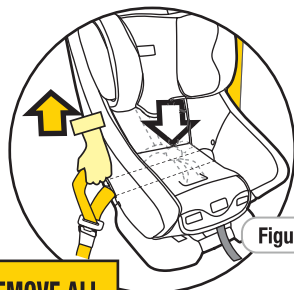

Figure 4

Step 4: Ensure the excess slack in the sash belt, is fed back towards the seat belt.

Ensure there are no twists in the seatbelt.

REMOVE ALL SLACK FROM SEATBELT

Installation

Child Car Seat

Forward Facing

Installing Using Vehicle Seatbelt

Safe Grip (If Supplied)

*Can be purchased separately visit www.securesafe.com.au

SAFE GRIP BELT CLAMP

The **Safe Grip** (red belt clamp) **locks the lap belt** to ensure a firm installation, and avoids slack in the lap belt.

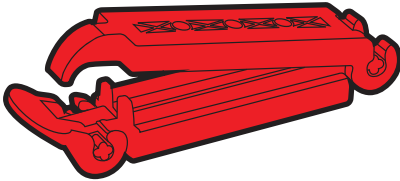

To install the **Safe Grip** (red belt clamp), open it and clamp the “sash section” ONLY of the vehicle seat belt by closing the barrel section of the red belt clamp in the direction of arrow 1 in Figure 5 and then locking with the toggle section by pushing in the direction of arrow 2 in Figure 5 when the **Safe Grip** (red belt clamp) is secured in place, the lap section is now tightly holding your child restraint in place, independent of the sash section. The **Safe Grip** (red belt clamp) must be removed when the child restraint is not installed to allow other users to use the seat belt as a lap/sash seat belt. Always keep the **Safe Grip** (red belt clamp) in pocket provided when not in use.

NOTE: Do not place the **Safe Grip** (red belt clamp) around both the lap and sash sections of the belt. This could cause the **Safe Grip** (red belt clamp) to break.

Adjusting Recline Angle

NOTE: To adjust the recline angle of the child restraint refer to “Converting to Child Car Seat” on page 39.

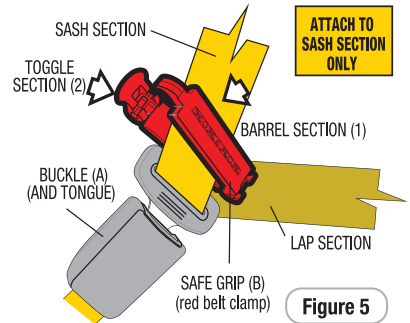

Figure 5

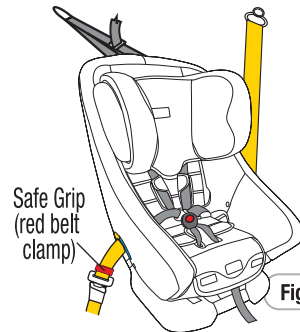

Figure 6

Installation

Child Car Seat

Forward Facing

Installing Using Vehicle Seatbelt

Note: If no upper anchorage fitting is available refer to pages 64 & 65.

Step 5: Hook the attachment clip to the anchor fitting. **Ensure there are no twists in the top tether strap** (refer to Figure 7).

Step 6: Pull to tighten to remove all the slack, from the upper anchorage strap. Create a firm installation by tightening the upper anchorage strap (refer to Figure 8).

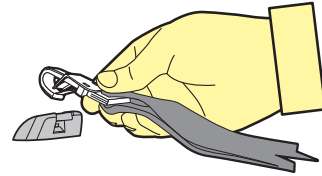

Figure 7

NOTE

FOLLOWING THE INSTALLATION OF THE CHILD RESTRAINT A SMALL AMOUNT OF MOVEMENT IS DEEMED ACCEPTABLE.

CAUTION: CHILDREN CAN BE INJURED OR RESTRAINTS AND TOP TETHER STRAP DAMAGED BY UNSECURED CARGO IN A COLLISION. SECURE OR REMOVE HAZARDOUS CARGO BEFORE USING THIS CHILD RESTRAINT.

Always secure the loose end of the top tether strap to prevent it hanging out of the car or being accessible by the child.

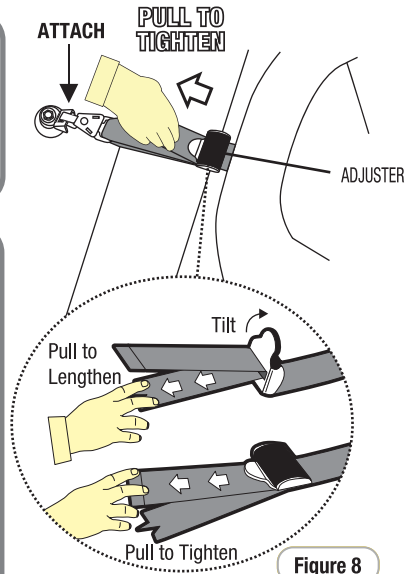

Figure 8

Tether Storage

Store any excess webbing, from the top tether strap, in the storage pocket provided on the restraint (refer to Figure 9).

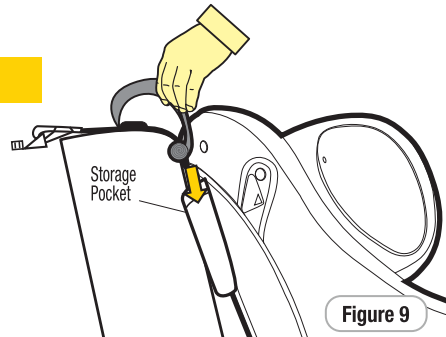

Figure 9

Using Inbuilt Harness

- Step 1:** Ensure the restraint has been set up and installed as per “Setup” and “Installation” (refer page 39-51).
- Step 2:** To lengthen the harness “LIFT” the harness adjuster (refer Figure 1) whilst grasping both shoulder harness straps and pulling. Ensure shoulder straps are pulled equally on each side.
- Step 3:** Place the child in the restraint with legs either side of the buckle, place the harness over the shoulders and hips (refer Figure 2).

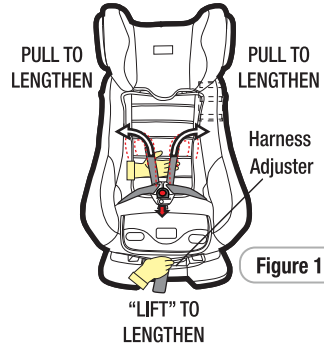

Figure 1

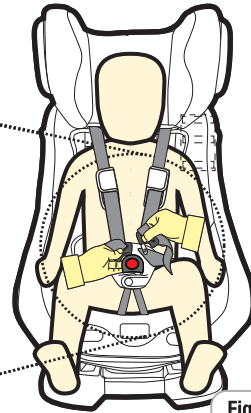
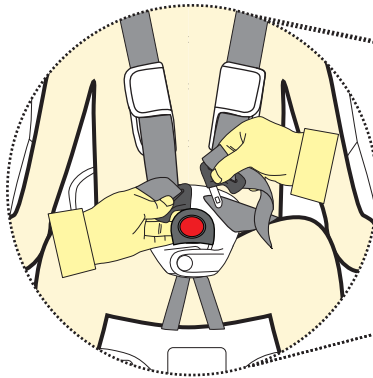

Figure 2

NOTE: To change the buckle height refer to “Buckle Height Adjustment” (refer page 43).



IMPORTANT

KEEP BUCKLE LOW AS POSSIBLE

Always ensure buckle has clearance from the upper thighs (see indicated area Figure 3).

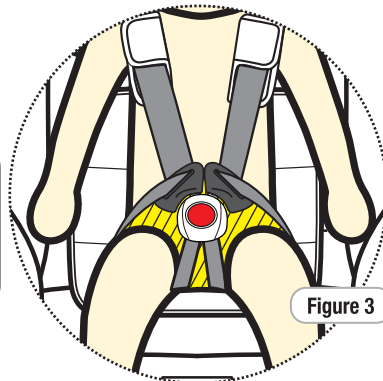

Figure 3

Using Inbuilt Harness

Step 4: Insert either tongue into the buckle followed by the other tongue until a **“CLICK”** is heard. Should the second tongue not insert, press the red button and reinsert the tongues. Ensure secure engagement by pulling the harness strap (refer Figure 4).

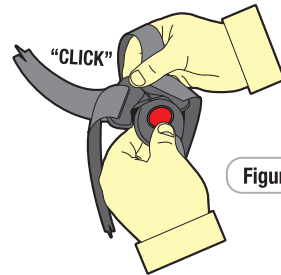
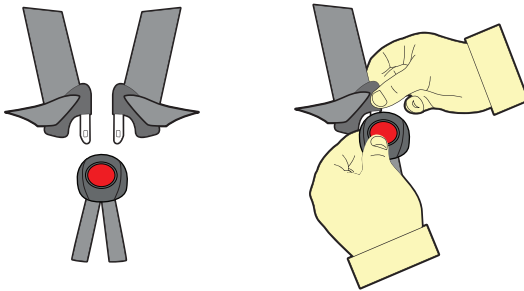

Figure 4



IMPORTANT

If no “Click” can be heard or a secure engagement cannot be achieved refer to “Cleaning Buckle Harness” page 57.

Step 5: Remove all of the slack for the harness lap straps by pulling shoulder straps (refer Figure 5), then pull the harness adjustment strap to adjust harness to a comfortable but firm fit (refer to Figure 5 & 6).

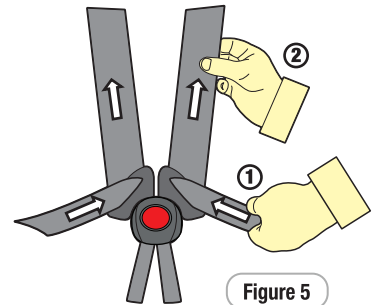

Figure 5



WARNINGS

- **DO NOT LEAVE CHILDREN UNATTENDED IN THE CAR.**
- Fit the harness firmly to the child.
- **A LOOSE HARNESS IS DANGEROUS**

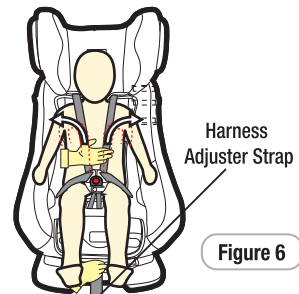

Figure 6

PULL TO TIGHTEN

REMOVE ALL SLACK FROM HARNESS

Using Inbuilt Harness

Step 6: Check the harness tightness by the **PINCH TEST**, this is achieved by pinching the harness webbing at the shoulders (refer Figure 7).

- If you can pinch the harness strap, tighten more.
- If your fingers slip off, then the harness is tight enough.

If required repeat Step 5.

IMPORTANT

- The Padded Insert/s (if fitted) are designed to provide extra support and comfort for small babies. Discontinue use when the insert is a tight fit or creates discomfort for larger babies/children.
- Always adjust the height of the shoulder straps as the child grows.

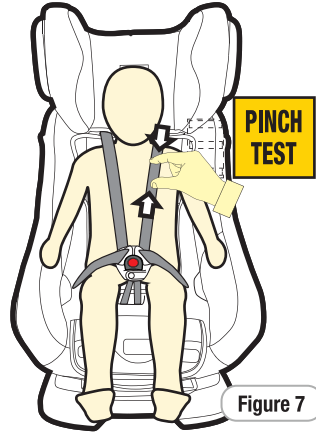

Figure 7

Adjusting Recline Angle

NOTE: To adjust the recline angle of the child seat refer to “Converting to Child Car Seat” on page 39.

Step 1: First loosen the seatbelt assembly, the Safe Grip Belt Clamp may need to be removed.

Step 2: At the front of the restraint is a blue* lever. Pull the blue* lever forward and slide the restraint to obtain the desired upright or reclined angle (refer Figure 1). *Colour may vary.

Step 3: Reinstall the seatbelt and Safe Grip Belt Clamp (refer page 50).

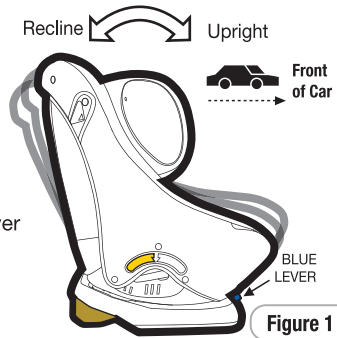

Figure 1

To Release Child

Step 1: To release your child from the restraint simply press the harness buckle and carefully remove your child from the restraint (refer Figure 1).

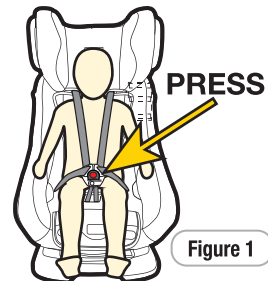
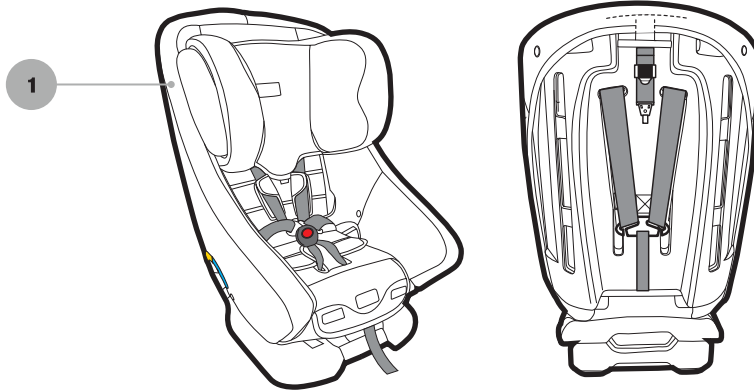

Figure 1

Care of Restraint

The child restraint cover has been manufactured to meet the Australian Standards requirements for flammability and toxicity to ensure your child's safety. The cover has also been designed to provide your child with comfort and support.



1. Main Cover

VERY IMPORTANT

Only replace the cover with a SecureSafe supplied replacement cover with identical shoulder height markers or a replacement cover meeting AS/NZS 8005.

Care and Maintenance

Regular care of the restraint will ensure safety of your child.

- Check the webbing for fraying.
- Check the upper anchorage attachment clip to ensure retainer clip is still present.
- Ensure there are no cracks in moulding or the plastic moulding.
- Check the buckles “click” when you engage tongues and is not sluggish or sticky in operation.
- Ensure the buckle is free of fluff, liquid, or other matter that may enter the buckle slots. Clean the buckle if it is sluggish to engage (refer Cleaning Buckle page 57).
- Check the harness adjuster is operating and is clamping the webbing.
- If any part of the restraint is cracked or broken, seek repair immediately or replace the child restraint.

Cleaning

IMPORTANT

Use only mild soap and water to clean all parts of the CS8713 Convertible Car Seat.
Do not use chemicals or cleaning agents
Cold water only to be used and to be rinsed well
Do not dry clean or tumble dry
Do not bleach.

Covers

The restraint has a flame retardant cover which is removable for cleaning. Cleaning instructions are on the care label attached to the cover. If a fluffy cover is fitted, then washing the cover prior to use will remove excess fluff.

The cover has been designed to protect your child when seated in the restraint. Care should be taken, if children either eat or drink while in the restraint, as some food or drink products may cause damage or marking to the cover. Wash or clean immediately. Do not pull sticky items from covers as the cover may be damaged - soak in water and gently remove.

Only machine wash on gentle cycle (hand washing is recommended). When washing the covers, ensure the hook and loop attachment strips are connected to eliminate other materials or garments being caught. Ensure that the hook and loop attachment strips are free of lint, this will ensure a positive engagement.

IMPORTANT

For **Velour** or **Leatherette** fabric only sponge clean with a damp cloth.

Seat + Hardware

Use only mild soap and water to clean all webbing, metal and plastic parts of the restraint using a damp cloth.
Do not use chemicals or cleaning agents.

Harness Straps

Use only mild soap and water to clean all straps, using a damp cloth the harness straps can be soaked, however they must be thoroughly dried without excessive heat (never tumble dry). The harness straps should not be placed in a washing machine as this may cause damage to the stitching or even damage your washing machine.
Do not use chemicals or cleaning agents.

Cleaning

Harness Buckle

If sticky liquids such as baby formula, fruit juice, etc. get inside your Harness Buckle, it may become sluggish. An indication of a sluggish Harness Buckle is that you cannot hear a **“CLICK”** when engaging the Harness Tongues. To restore the Harness Buckle to good working order it needs to be cleaned as follows:

Step 1: From the underside of the restraint pull each crotch 3-bar slide then turn 3-bar slide and push through each slot to remove the Harness Buckle from the restraint (refer Figure 1).

Step 2: Place the Harness Buckle under warm (max. 40 degrees Celsius) running water as shown below. Let the water run through the mouth of the buckle for five minutes (refer Figure 2).

Step 3: Engage and disengage the Harness Tongues and Buckles several times until a strong audible **“CLICK”** is heard when inserting the last tongue (refer Figure 3).

Step 4: If you still cannot hear a strong audible click after engaging the Harness Tongues and Buckle, then repeat cleaning several times. If the Harness Buckle cannot be returned to its original working condition then contact SecureSafe Customer Care:
AU: 1300 92 4632 NZ: +61 2 4728 8090

Step 5: Refit the harness buckle to the restraint with the red button facing out and feeding each 3-bar slide through appropriate slot. Always ensure the webbing crotch straps are thoroughly dried before installing.

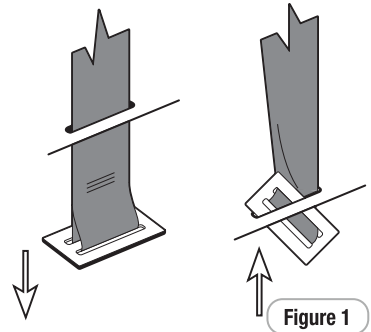

Figure 1

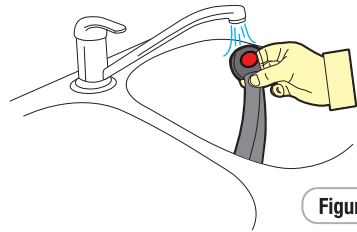

Figure 2

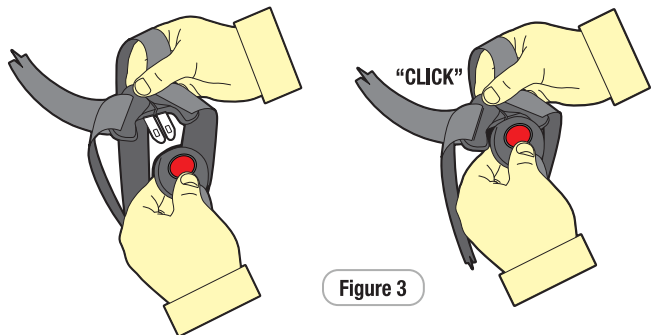

Figure 3

Cleaning

Headrest

Step 1: Raise the headrest to highest position (refer Figure 1).

Step 2: Unclip the press studs located:

- 1 underside of headrest.
- 2 behind headrest.

Step 3: Remove cover

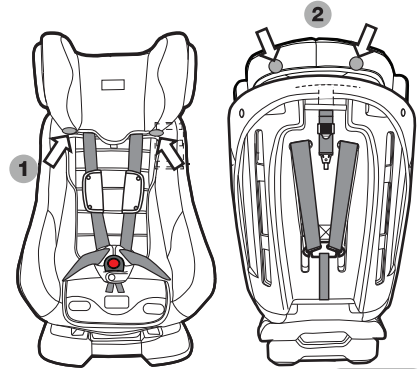

Figure 1

Apron

Step 1: Unclip the press studs location 1 (refer Figure 2).

Step 2: Slide cover off the plastic apron to remove.

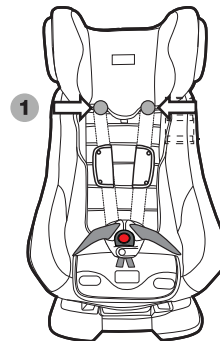

Figure 2

Remove & Replace Covers

Main Cover

Step 1: Loosen harness to allow spreader plate to rise from under the restraint. Turn the restraint so that the back of the restraint is facing you.

Step 2: Remove each shoulder harness through the gates in the spreader plate (see Figure 1 & 3).

Step 3: Pull the shoulder harness straps through the shoulder slot holes in the restraint body and cover. They are now loose in the front of the restraint.

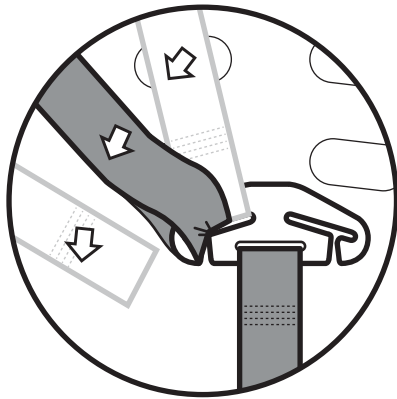

Figure 3

Step 4: Unclip the press studs located;

- 1 back of restraint.
- 2 both sides of restraint.

Step 5: Remove cover

Step 6: *Replace in reverse.

NOTE: Press stud cover location may vary between different models.



Figure 1

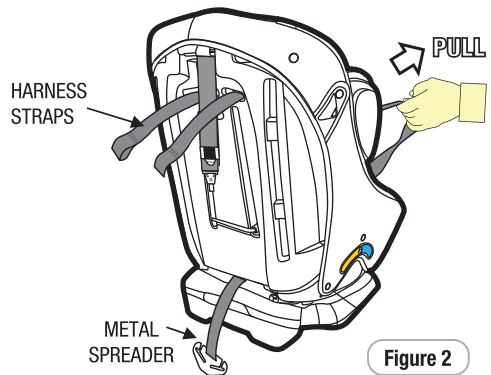

Figure 2

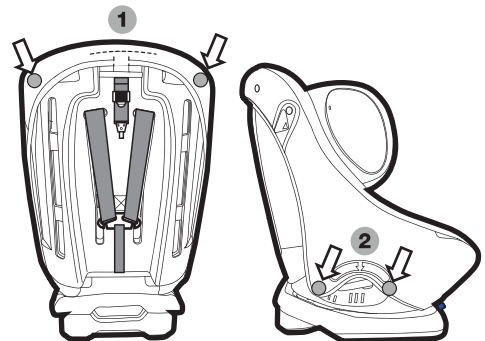
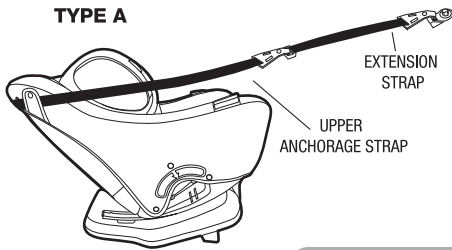

Figure 4

Extension Straps

If required contact SecureSafe for nearest supply location. Extension straps, not included in this package, may be required for vehicles without a fixed parcel shelf.



INFANT SEAT

Re order Line Numbers

CS111 300mm Length

CS112 600mm Length

CS113 200mm - 900mm
Adjustable Length

If required contact SecureSafe
Customer Care 1300 92 4632 (AU)
or +61 2 4728 8090 (NZ) for nearest
supply location.

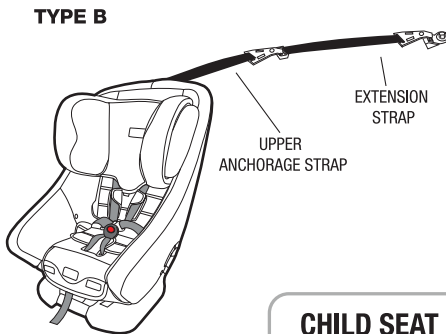

CHILD SEAT

Accessories

Follow the instructions covering the use of accessories provided with this child restraint or spare parts provided by SecureSafe for this restraint.

IMPORTANT

Use of unauthorised aftermarket accessories (i.e items not provided in this box with the child restraint), can reduce the safety provided by the child restraint and may cause injury or death.

PADDED INSERTS (if fitted)

The padded inserts are designed to add extra comfort for your child.

- Step 1:** Press to release Buckle tongues.
- Step 2:** Open the “press studs” and position the padded insert in the restraint.
- Step 3:** Pass the harness straps over the insert and connect the “press studs”.
- Step 4:** Pull the Buckle and leg straps through the slot or opening in the insert.
- Step 5:** Connect both tongues into the buckle.

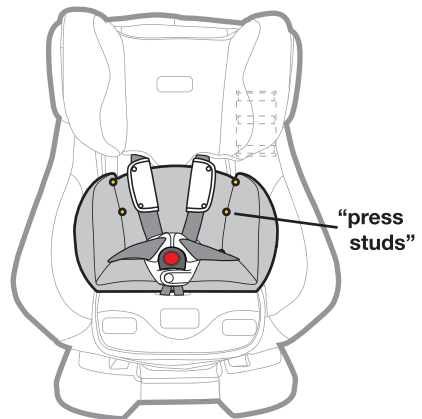

BUCKLE PAD (if fitted)

The buckle pad is designed to add extra comfort for baby or child.

- Step 1:** Position the buckle pad behind the buckle and clip in the front. The release button should be clearly visible.



Accessories

SHOULDER PADS (if fitted)

Alternative Pads

Step 1: Separate press-studs and remove the shoulder pads from harness

Step 2: To attach shoulder pads, ensure press studs face away from the child and re-attach.

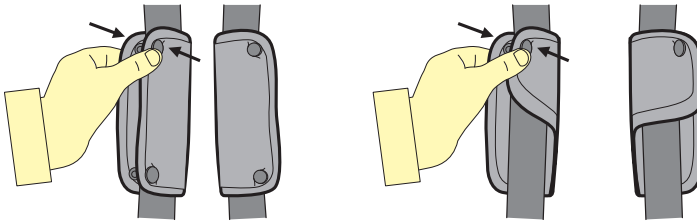

Accessories

SEAT PROTECTOR (if fitted)

The seat protector is designed to protect your car's seat.

STANDARD

Step 1: Position the front flap with pockets, at the front of the rear seat and position the mat rearwards to obtain a flat fit.

FULL LENGTH

Step 1: Position the front flap with pockets, at the front of the rear seat and position the mat rearwards to obtain a flat fit. (If required an additional flap has been provided to tuck in between the seat back & cushion)

Step 2: Position the back section up the seat back and use the plastic buckle & webbing strap to attach around the vehicle seat headrest (if the rear vehicle seat does not have a headrest then the strap could be used to attach around the child seats top tether after you have installed the child seat).

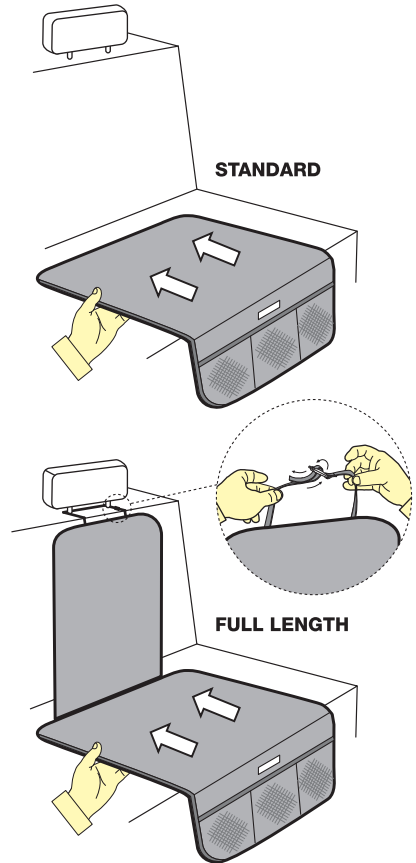

Anchorage Fittings

Some vehicles may have an anchor fitting already fitted by the vehicle manufacturer.

If no anchorage points can be found refer to the vehicle manufacturer, or an authorised child restraint fitting station for the best location of an anchorage point.

Refer to the vehicle owners handbook or child restraint fitting station for the possible use of spacers.

Some vehicles may require the use of additional extension straps (not supplied with this child restraint)

If so ring SecureSafe on 1300 92 4632 (AU) or +61 2 4728 8090 (NZ) for nearest supply location.
ADDITIONAL EXTENSION STRAPS AVAILABLE:
 CS111 300mm Extension strap
 CS112 600mm Extension strap
 CS113 200 - 900mm Adjustable Extension strap



WARNINGS

- Top tether strap and attachment clip must always be used
- Always ensure that the upper attachment clip is correctly engaged to the anchor fitting
- **THIS RESTRAINT MUST BE ATTACHED TO A CHILD RESTRAINT ANCHORAGE POINT IN THE CAR. REFER TO CAR OWNER'S HANDBOOK FOR LOCATION OF ANCHORAGE POINTS. REFER TO A CHILD RESTRAINT FITTING STATION IF NO CAR ANCHORAGE POINTS ARE IN THE MOTOR CAR.**
- **THIS RESTRAINT IS NOT SUITABLE FOR USE WHERE TOP TETHER STRAP MAY FALL INTO A SPLIT IN THE SEAT BACK OR OFF THE SIDE OF THE SEAT.**

For cars fitted with a child restraint anchorage point

THIS RESTRAINT MUST BE ATTACHED TO A CHILD RESTRAINT ANCHORAGE POINT IN THE CAR. LOCATE THE ANCHORAGE POINT BEHIND THE REAR SEATING POSITION. CONSULT THE CAR OWNER'S HANDBOOK FOR LOCATION OF ANCHORAGE POINTS. REMOVE THE THREAD PLUG FROM THE PARCEL SHELF/FLOOR/ROOF AND INSTALL THE ATTACHMENT BOLT AS SHOWN IN FIGURE 1A & 1B.

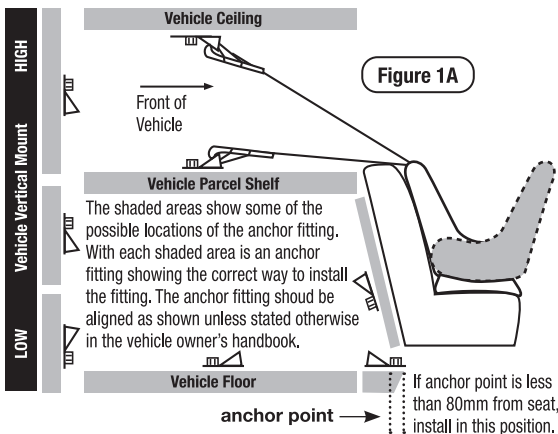

WARNING: If A.D.R. anchorage point is recessed, spacer(s) may be required. Spacer Part No's are as follows:
 10mm - CCS001;
 5mm - CCS002

CAUTION: DO NOT OVERTIGHTEN ATTACHMENT BOLT. MAXIMUM TORQUE IS 20NM.

UPPER ANCHORAGE FITTINGS

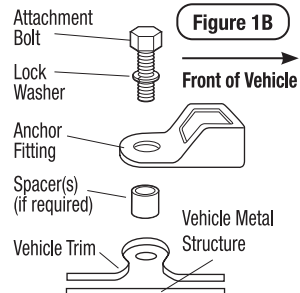

Anchorage Fittings

For cars not fitted with a child restraint anchorage point

For Sedans Only

Drill a 9mm diameter hole in the parcel shelf on the centre line of the seating position as shown in Figure 1C. Hole must be no closer than 200mm from the front of the back seat. Install the anchor bolt as shown in Figure 1D.

Note to Queensland purchases: The installation of anchorage points must be approved by authorised officers appointed by Queensland Transport. Authorised officers can be sourced from all Queensland Transport Customer Service and Queensland Ambulance Service Centres.

For Vehicles other than Sedans

In Australia, consult your nearest child restraint fitting station of traffic authority for vehicle inspection to find the best, correct position for the placement of the anchorage point, and for the correct attachment bolt length use of spacers.

In New Zealand consult the agent of the vehicle.

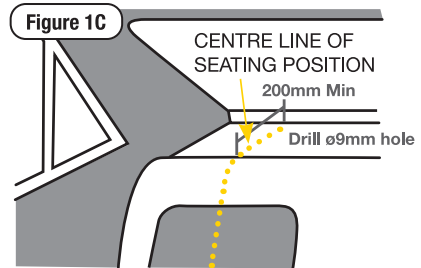

UPPER ANCHORAGE FITTINGS FOR SEDANS ONLY

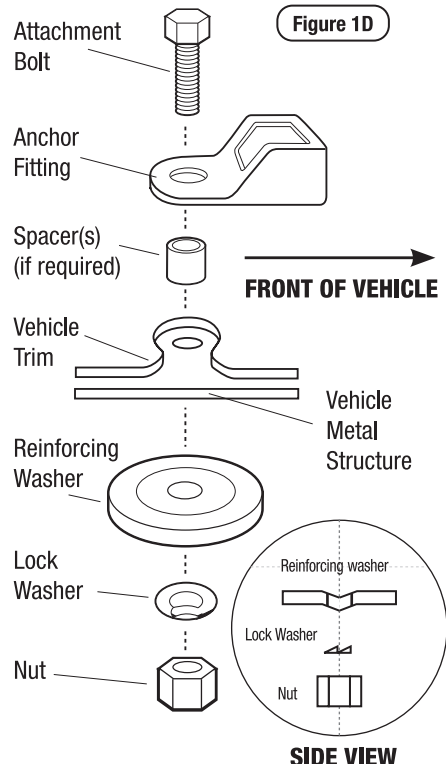

WARNINGS

CHILD RESTRAINTS MUST NOT BE ATTACHED TO UNSOUND METAL OR WOOD OR SYNTHETIC STRUCTURES. WHEN DRILLING THE 9MM HOLE DO NOT DRILL THROUGH FUEL LINES, FUEL TANKS, ELECTRICAL WIRING OR RADIO SPEAKERS. WEBBING STRAPS MUST BE PROTECTED FROM SHARP CORNERS AND EDGES.

THE ANCHOR FITTING MUST BE USED ONLY AS DESCRIBED ABOVE. IT MUST NOT BE HOOKED ONTO ANY OTHER OBJECT.

Insurers Information

If your restraint has been involved in a severe crash, you should destroy the restraint even if no damage is obvious. Some insurance companies offer vehicle insurance which covers or partially covers the replacement of your child restraint. Contact your insurance company for further details.

Your insurance company may require you to keep the child restraint for assessment, but do not use the child restraint after a severe crash. To assist you in making an accident insurance claim cut the following statement and include it with your claim.

NOTICE TO INSURANCE COMPANY CHILD RESTRAINT INVOLVED IN AN ACCIDENT

All SecureSafe child restraints are manufactured to Australian/New Zealand Standards AS/NZS1754 which requires us to advise users of child restraints to "Destroy the entire restraint if it has been in use in a severe crash, even if no damage is obvious".

The Australian/New Zealand Standards committee, advise that this statement applies whether a child was in the child restraint or not. We consider a "severe crash" as being one where the main body structure of the vehicle is distorted.

There is no method of determining if the restraint has been damaged and we concur with the Australian/New Zealand Standards in recommending destruction of the child restraint.

This notice is to advise you of the requirements of the Australian/New Zealand Standards and our obligation in complying with the standards.

Please assist the owner of this restraint in their claim.

INFASECURE PTY LTD ABN: 52 149 173 660

Head Office and Registered Address
110-114 Old Bathurst Rd, Emu Plains, NSW 2750
P.O. Box 487, Emu Plains, NSW 2750

Customer Care

AU: 1300 92 4632

NZ: 067 590 870

www.securesafe.com.au



LIFETIME WARRANTY

ON SUPER STRONG BLOW MOULDED SHELL PRODUCTS

Register your product to receive **lifetime warranty***, product updates and information.

 Please visit [securesafe.com.au/warranty-registration](https://www.securesafe.com.au/warranty-registration) to register your product.

SecureSafe Warranty

SecureSafe Pty Ltd warrants this product for twelve months from the date of purchase against failure due to manufacturing faults or faulty materials. Misuse, accidental damages, normal wear and tear are not covered by this warranty.

When used for commercial use the period is limited to six months. "Our goods come with guarantees that cannot be excluded under the Australian Consumer Law. You are entitled to a replacement or refund for a major failure and for compensation for any other reasonably foreseeable loss or damage. You are also entitled to have the goods repaired or replaced if the goods fail to be of acceptable quality and the failure does not amount to a major failure."

Additional Warranty on Blow Moulded Child Restraints

Our blow moulded child restraints are covered against faulty materials and manufacturing when used under normal conditions and according to the instructions.

In the unlikely case that you do have a fault in relation to material quality or manufacturing that restricts your ability to use your Child Restraint normally, we will repair or replace the product within the following warranty periods from date of purchase:

- 12 month warranty for material and fabrics
- 2 year warranty for straps and webbing
- 5 year warranty for hardware and fittings
- Lifetime warranty* on the manufacturing of the seat moulding

Please read your instruction manual carefully before using any of our products.

The above express warranties do not apply where a failure or defect results from improper care, misuse or from normal wear and tear.

Refer to website for more details: www.securesafe.com.au

*Lifetime warranty refers to the life span of the seat which is 10 years from the Date of Purchase.

Secure Safe

INFA GROUP

 secursafe.com.au

 facebook.com/secursafeAU

 instagram.com/secursafeAU

INFASECURE PTY LTD ABN: 52 149 173 660

Head Office and Registered Address
110-114 Old Bathurst Rd,
Emu Plains, NSW 2750
P.O. Box 487, Emu Plains, NSW 2750

CUSTOMER CARE

AU: 1300 92 4632 **NZ:** 067 590 870 Email - customer care@infa.com.au



**Australian
Standard**

AS/NZS: 1754:2013
Licence No. 25324-1
SAI Global

ISSUE: D