



**4** **To** **8**  
YEARS YEARS

## Booster Seat

FORWARD FACING CAR SEAT

CS6213

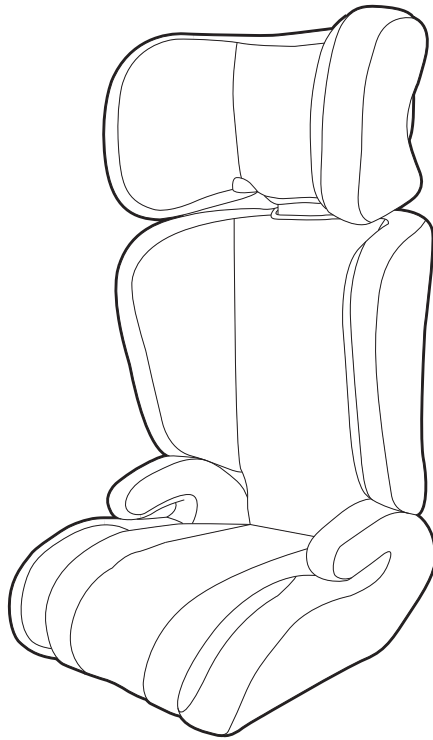

### BOOSTER SEAT

Boosters Seat: Suitable for children from 4 years to approximately 6 to 8 years\* of age.

## Instruction Manual

**IMPORTANT: KEEP THIS BOOKLET IN THE PLACE PROVIDED  
ON THE CHILD RESTRAINT**

\*All references to age are approximates only and reference to children of average proportions. Children vary in shapes and sizes. The photo displayed is indicative of the type of restraint and may vary slightly depending on the model.



**Australian  
Standard**

AS/NZS: 1754:2013  
Licence No. 25324-2  
SAI Global

Forward Facing Mode (Use for toddlers)

**INSTALLATION**

REFER TO PAGES 11 - 12

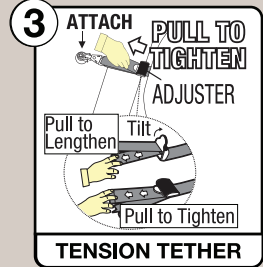
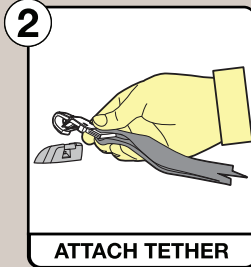
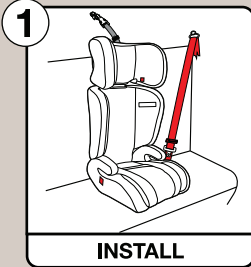

**ADJUST HEADREST  
(SASH GUIDE POSITION)**

REFER TO PAGE 13

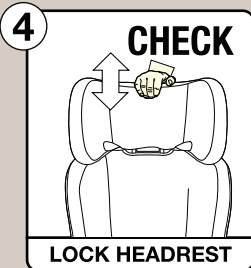
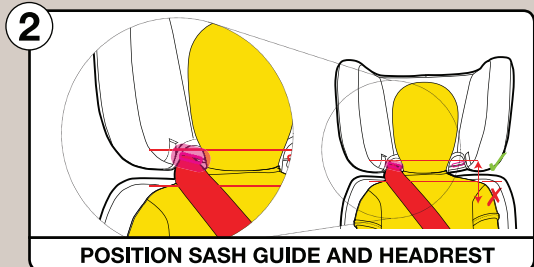
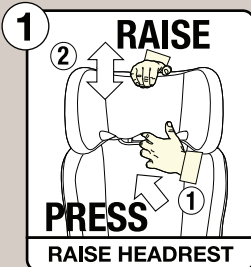

**Booster Seat Mode (Use for children)**

**USE**

REFER TO PAGES 13 - 17

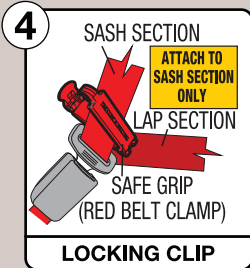
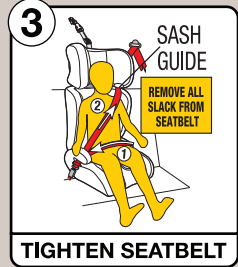
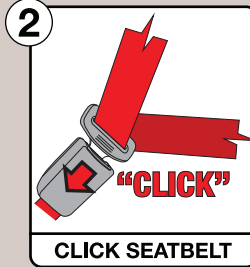

# Contents

Contents	1
Information	2
Warnings	3
Restraint Guide	5

## Booster Seat

Information	6
Shoulder Height Marker	7
CS6213 Child Restraints (Itemised list)	9
Next Restraint	10
Installation	
- Installing Using Vehicle Seatbelt	11
Use	
- Adjusting the Headrest	13
- Using Seatbelt	14
- To Release Child	17
Care of Restraint	
- Care and Maintenance	18
- Cleaning	19
Remove & Replace Covers	20
Extension Straps	20
Accessories	21
Anchorage Fittings	22
Insurers Information	24
Lifetime Warranty	28

Please read carefully the whole of the instructions for installation and, in the event of doubt about the method of installation, to consult InfaSecure or agent, or a child restraint fitter, or in New Zealand, to consult the agent for the vehicle.

# Information

This instruction manual covers various models under the Model number CS6213. This Booster Seat is designed to be used by children from approximately 4 Years of age up to approximately 8 years of age. These are installed in the back seat of the vehicle using the vehicle seatbelt & the top tether strap.

## **Air Cocoon Technology™ - A Protective Embrace**

Air Cocoon Technology™ (A.C.T.) enhances protection by dramatically reducing the impact forces during a crash. A.C.T. utilises a layer of air held inside the entirety of the child restraint shell, offering an increased level of protection across the entire surface area of the restraint. Your child is quite literally cradled in a cocoon of air, offering a true 180 degrees of protection to your child's vital organs.

Air Cocoon Technology™ integrated child restraints start their life as an actual pillow of air. This pillow is moulded into a child restraint, retaining the pillow-like construction while adding incredible strength and structural integrity. This manufacturing process is called blow-moulding.

Air Cocoon Technology™ (A.C.T.) is an all encompassing protective 'cocoon' around your child.



## **Child Restraints**

No child restraint can guarantee absolute protection from injury in every crash. However, to ensure that your child gets all the protection designed into the restraint please read and follow the instructions exactly and use only InfaSecure recommended parts and accessories.

## **Family Business**

InfaSecure is an Australian owned and operated family business, which can trace it's roots back over 60 years in business, becoming the single largest Australian owned and operated child restraint company in the country. Today, we are still growing, continuing to innovate and provide high quality products at an affordable price.



# Warnings



## WARNINGS

- Use the restraint exactly as shown in the instructions.
- Supervision of children is needed because they may be able to undo buckles.
- **DO NOT LEAVE CHILDREN UNATTENDED IN THE CAR.**
- Do not alter or modify this restraint.
- Repairs must only be done by the manufacturers or agent.
- Do not allow the restraint to come into contact with polishes, oils, bleach and other chemicals.
- Destroy the restraint if it has been in a severe crash, even if no damage is visible.
- **DO NOT USE THIS RESTRAINT WITHOUT THE COVER.**
- Always secure the loose end of the top tether strap. Do not use the child restraint where this strap may fall into a split in the seat back or off the side of the seat.
- **ALWAYS ATTACH HOOK AND REMOVE SLACK.**
- **DO NOT USE WITH JUST A LAP BELT. You must use with a lap-sash belt.**
- The lap part of the seat belt must be firmly across the thighs and the sash belt fitted diagonally across the chest and on the shoulder.

# Warnings



## WARNINGS



















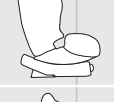

- THIS RESTRAINT IS NOT SUITABLE FOR USE WHERE THE TOP TETHER STRAP MAY FALL INTO A SPLIT IN THE SEAT BACK OR OFF THE SIDE OF THE SEAT.
- THIS RESTRAINT MUST BE ATTACHED TO A CHILD RESTRAINT UPPER ANCHORAGE POINT IN THE CAR. REFER TO CAR OWNER'S HANDBOOK FOR LOCATION OF ANCHORAGE POINTS. REFER TO A CHILD RESTRAINT FITTING STATION IF NO ANCHORAGE POINTS ARE IN THE MOTOR CAR.
- Always secure the loose end of the top tether strap to prevent it hanging out of the car or being accessible by the child.
- Do not use the child restraint where this strap may fall into a split into the seat back or off the side of the seat.
- IF AN AIRBAG IS FITTED IN THE SEATING POSITION WHERE THE CHILD RESTRAINT IS TO BE FITTED, FOLLOW THE VEHICLE MANUFACTURER'S WARNINGS AND INSTRUCTIONS.
- This child restraint is not approved for use with any connectors that connect to the car's ISOfix low anchorages

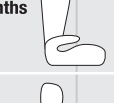

## WARNING

**DO NOT LEAVE CHILDREN UNATTENDED IN THE CAR.**

# Restraint Guide

MODE	Infant Seat		Child Seat		Booster Seat		Seat Belt		
	BIRTH	2	4	6	7	8	10	12+	
<b>REARWARD-FACING RESTRAINT (TYPE A1)</b> BIRTH TO APPROX 6 MONTHS 	REQUIRED BY LAW								
<b>CONVERTIBLE CAR SEAT (TYPE A2/B)</b> BIRTH TO 4 YEARS 	REARWARD FACING	FORWARD FACING		Approx 0 to 4 years					
<b>CONVERTIBLE CAR SEAT (TYPE A4/B)</b> BIRTH TO 4 YEARS 	REARWARD FACING		FORWARD FACING	Approx 0 to 4 years					
<b>CONVERTIBLE CAR SEAT (TYPE A4/G)</b> BIRTH TO 8 YEARS 	REARWARD FACING					FORWARD FACING	Approx 0 to 8 years		
<b>ZERO TO 8 CONVERTIBLE CAR SEAT (TYPE A2/B/E)</b> BIRTH TO 8 YEARS 	REARWARD FACING	FORWARD FACING		BOOSTER SEAT			Approx 0 to 8 years		
<b>FORWARD-FACING RESTRAINT (TYPE B)</b> APPROX 6 MONTHS TO 4 YEARS 	FORWARD FACING			Approx 6 months to 4 years					
<b>FORWARD-FACING RESTRAINT (TYPE G)</b> APPROX 6 MONTHS TO 8 YEARS 	FORWARD FACING						Approx 6 months to 8 years		
<b>CONVERTIBLE BOOSTER SEAT (TYPE B/E)</b> APPROX 6 MONTHS TO 8 YEARS 	FORWARD FACING			BOOSTER SEAT			Approx 6 months to 8 years		
<b>BOOSTER SEAT (TYPE E)</b> FROM APPROX 4 YEARS TO 8 YEARS 			Approx 4 years to 8 years	BOOSTER SEAT			LARGER BOOSTER SEAT		
<b>BOOSTER SEAT (TYPE F)</b> FROM APPROX 4 YEARS TO 10 YEARS 			Approx 4 years to 10 years	BOOSTER SEAT					
<b>SEAT BELT</b> FROM APPROX 7 YEARS AND OVER 							7 +	10 +	
							Allowable by law	More Appropriate	

**IMPORTANT:** Research has shown that the likelihood of an accessory child safety harness being used incorrectly is very high and the risk of injuries when incorrectly used is much higher compared to a lap-shoulder seat belt. InfaSecure recommend that an accessory child safety harness should only be used if a lap-only seat belt is all that is available.



# Booster Seat (Forward Facing)

## THE SUITABILITY OF THE CHILD RESTRAINT TO GROUPS OF CHILDREN

### TYPE E

To be used with a lap-sash seatbelt by a child whose shoulders are above the lower shoulder height marker with headrest in lowest position (approximately 4 years of age) until the child's shoulders reach the upper shoulder height marker with headrest in highest position (approximately 6 to 8 years of age).

Continue to use this booster seat until the child reaches this limit. Children are safest in a booster seat until their shoulders reach the upper shoulder height marker of the booster seat.

Do not use this booster seat until child's shoulders are above the lower shoulder height marker.

If the knees do not bend in front of the vehicle seat cushion continue to use a booster seat.

Just using a seatbelt is not recommended for children that have outgrown this seat. Use a larger booster seat.

**THIS RESTRAINT MUST BE USED IN CARS WITH FORWARD-FACING SEATS WITH A LAP-SASH SEATBELT. THIS BOOSTER SEAT IS NOT SUITABLE FOR USE WITH A CHILD HARNESS.**

**The use of child restraints in the front seat may be restricted for children of specific ages by local legislation. Please check with your local Department of Transport for the specific seating locations of children using child restraints for their given ages.**

## **IMPORTANT**

- For a vehicle without a fixed parcel shelf an extension strap(s) may be needed. If so ring 1300 92 4632 (AU) or 067 590 870 (NZ) for nearest supply location.
- Seatbelt extenders are not recommended to be used if the seatbelt is not long enough to secure the child restraint. If seatbelts are too short then advice should be sought from a child restraint fitter and their recommendation be considered before using a seatbelt extender.

## **IMPORTANT**

This child restraint is not approved for use with any connectors that connect to the low anchorages.

# Shoulder Height Markers

## Smaller Child (using lap-sash seatbelt)

Shoulder height markers are provided on this restraint for a visual indication that the child is safe to travel in this restraint. *Shoulder height markers may be hidden under a pillow in the lowest position.*

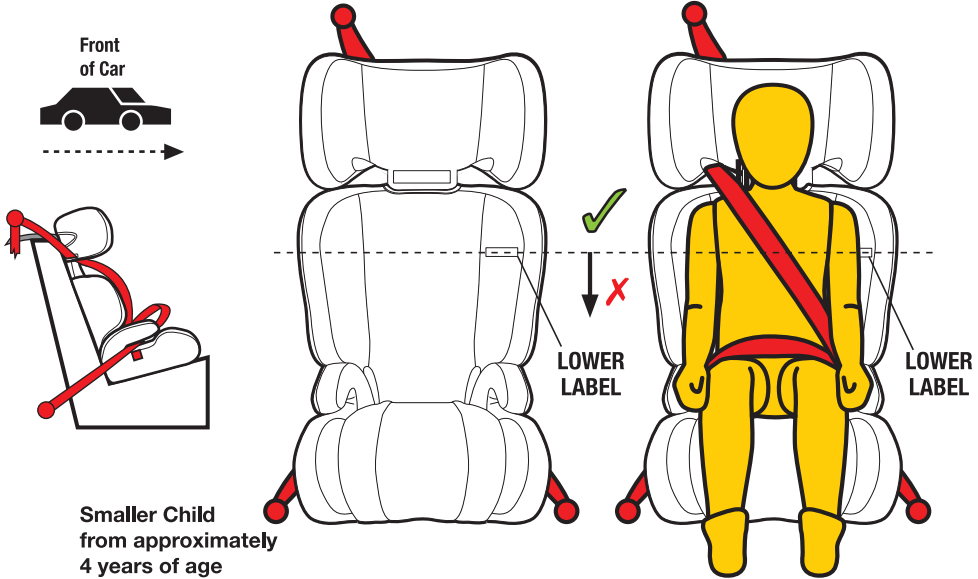

Smaller Child from approximately 4 years of age

Do not use as a booster seat until the child's shoulders are **ABOVE** the LOWER shoulder height marker (middle label).



### IMPORTANT

If moving a child from forward facing child restraint with an inbuilt harness, the child's shoulders will need to be inline or above the lower label with the headrest in the lowest position. If the child's shoulders are below the lower label with the headrest in the lowest position the child should continue to use the forward facing child restraint with an inbuilt harness

# Shoulder Height Markers

## Taller Child (using lap-sash seatbelt)

Do not continue to use the restraint if the child's shoulder are above the Upper Label.

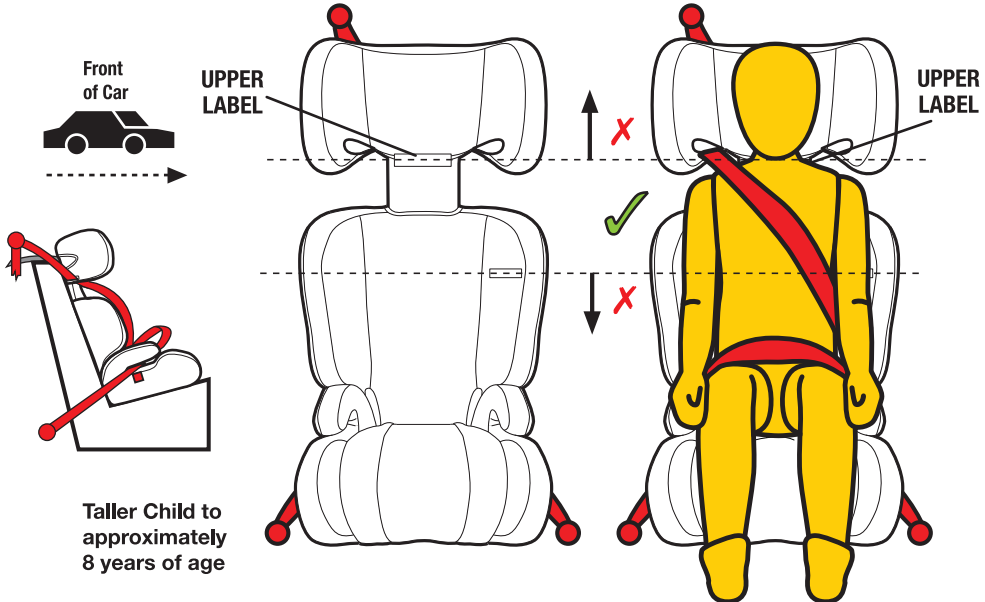

Taller Child to approximately 8 years of age

Continue to use this booster seat until the child's shoulders **REACH** the Upper shoulder height marker (Upper Label).

UPPER LABEL (Forward-Facing)



Children are at risk of serious injury if they move to booster seats too early.

Children that have outgrown the forward-facing child restraint are safest in a booster seat until their shoulders reach the upper shoulder height marker of the booster seat.

The child restraint is unsuitable for the occupant when the shoulders are above the upper marker. The child needs to be moved into the next form of child restraint eg. Larger Type E booster seat or Type F booster seat when they reach the top shoulder height marker.

For the next child restraint refer to the Restraint Guide on page 5.

# Model CS6213

Forward facing

## Booster Car Seat

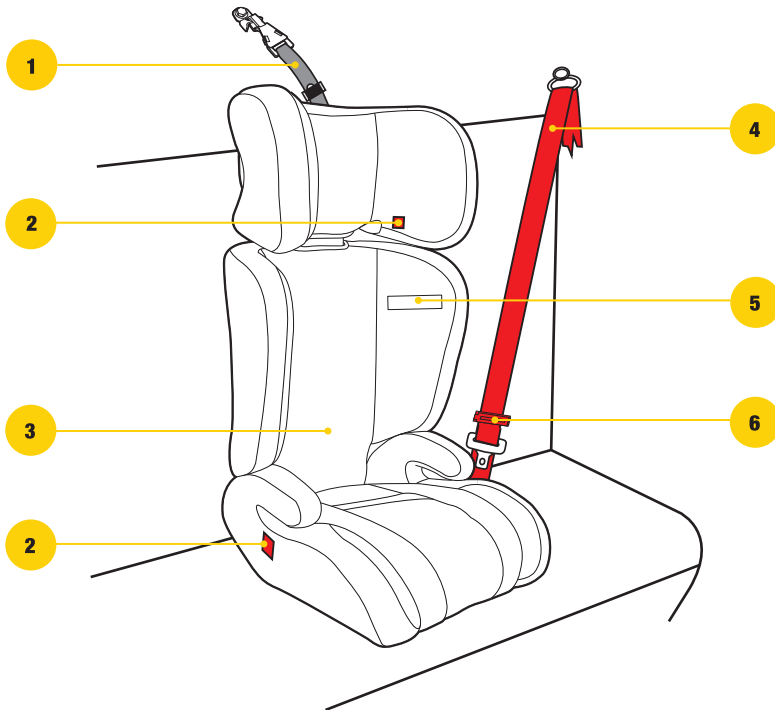

### 1. Top Tether Assembly

- Tether Strap
- Adjuster
- Attachment Clip
- Anchor Fitting + Attachment Hardware

### 2. "BOOSTER SEAT BELT PATH" Marker (each side of restraint - coloured red)

### 3. Comfort Cover

- Backrest • Seat Base

### 4. Vehicle Seatbelt

### 5. Shoulder Height Markers

### 6. SAFE GRIP Red Belt Clamp (if supplied\*)

\*These items may not be supplied with all models of the CS6213.

## **IMPORTANT**

- For a vehicle without a fixed parcel shelf an extension strap(s) may be needed. If so ring 1300 92 4632 (AU) or 067 590 870 (NZ) for nearest supply location.
- Seatbelt extenders are not recommended to be used if the seatbelt is not long enough to secure the child restraint. If seatbelts are too short then advice should be sought from a child restraint fitter and their recommendation be considered before using a seatbelt extender.

## Next Restraint

### Next Type of Restraint

Refer to the 'RESTRAINT GUIDE' for the selection for the most appropriate next restraint (refer Page 5). When the child has outgrown the booster seat, then you can use either of the following;

- **Large Booster Seat** – Larger type E or Type F Booster seat.
- **Vehicle Seat Belt** – check the "Five Step Test" for suitability.

### Five Step Test

Step 1: Can the child sit with their back against the vehicle seat back? (refer Figure 1).

Step 2: Do the child's knees bend in front of the edge of the seat? (refer Figure 2).

Step 3: Does the sash (shoulder) belt sit across the middle of the shoulder, not on the neck or out near the arm? (refer Figure 3).

Step 4: Is the lap belt sitting low across the hips touching the thighs? (refer Figure 4).

Step 5: Can the child stay seated like this for the whole trip? (refer Figure 5).

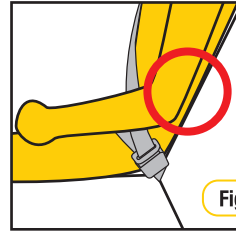

Figure 1

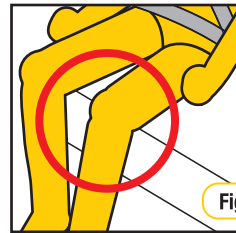

Figure 2



Figure 3



Figure 4

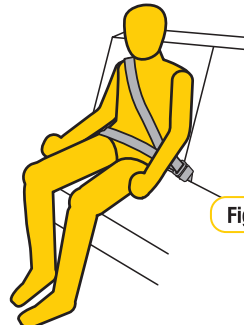

Figure 5

## Installation

### Installing in Vehicle

- Step 1:** Place the child restraint in the car, in a forward facing seating position (refer Figure 1).
- Step 2:** If required install the upper anchorage fitting as shown on page 22 & 23 of these instructions.
- Step 3:** Hook the attachment clip to the anchor fitting. Ensure there are no twists in the upper anchorage strap (refer Figure 2).

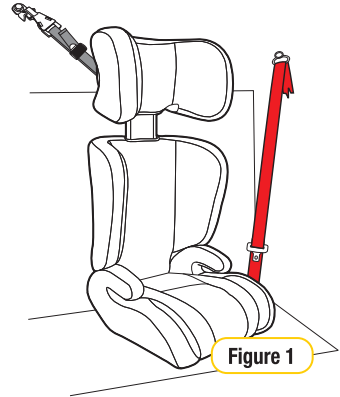

Figure 1



### WARNING

- DO NOT USE WITH JUST A LAP BELT. You must use a lap-sash seat belt.

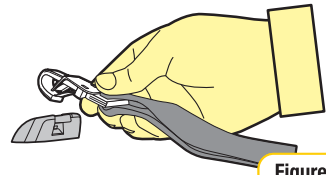

Figure 2

## Installation

### Installing in Vehicle

**Step 4:** Pull to tighten and remove all the slack, from the top tether strap (refer Figure 3). Do not overtighten as this could cause the restraint to lift off the vehicle seat.

**Step 5:** Roll up and store the excess webbing from top tether strap and store in the pocket provided (refer Figure 4).

**CAUTION: CHILDREN CAN BE INJURED OR RESTRAINTS AND TOP TETHER STRAP DAMAGED BY UNSECURED CARGO IN A COLLISION. SECURE OR REMOVE HAZARDOUS CARGO BEFORE USING THIS CHILD RESTRAINT.**

Always secure the loose end of the top tether strap to prevent it hanging out of the car or being accessible by the child.

### IMPORTANT

- Tighten till slack is removed.
- In certain vehicles an extension strap may be needed.
- Do not overtighten Top Tether strap.
- Ensure Top Tether strap is passed through the Top Tether Strap Guide.

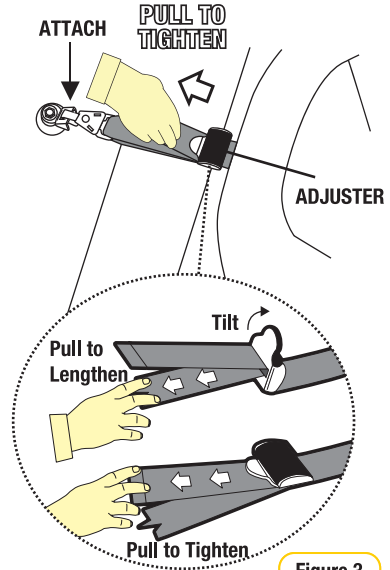

Figure 3

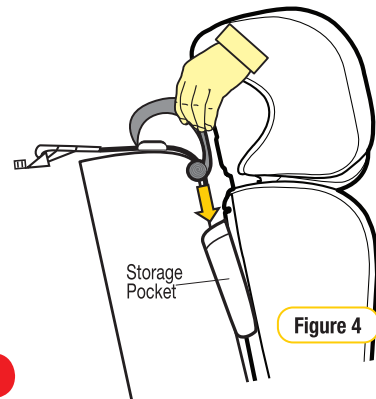

Figure 4

### Tether Storage

After correctly installing the restraint in your car, roll up and place any excess tether strap in the storage pocket provided (refer Figure 4).

## Use

### Adjusting the Headrest

The headrest can be adjusted to different heights to best suit your child. The headrest has a locking button in the front.

#### **IMPORTANT**

You will need your child to sit in the booster to determine the most appropriate headrest height.

The headrest height provides for;

- The sash guide position to ensure the vehicle seat sash is correctly located.
- The protection of your child's head during a side impact.

Note:

With the child correctly sitting in the restraint, check that the headrest is positioned just above the child's shoulders.

**Step 1:** Lift the flap on the front of the headrest cover, to expose the unlock/lock button.

- 1 Press the button to unlock the mechanism.
- 2 Raise/Lower to achieve the correct headrest position.

Release the button to lock the mechanism (refer to Figure 2).

**Step 2:** Adjusting the headrest height to position the sash guide near your child's shoulders to enable the car seat belt sash to be in the correct position (refer Figure 6)(see using Lap-Sash seat belt pages 14-16).

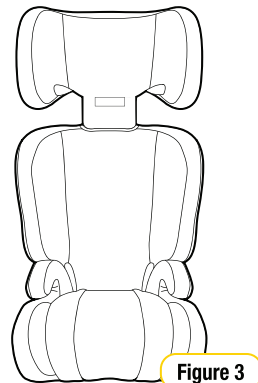
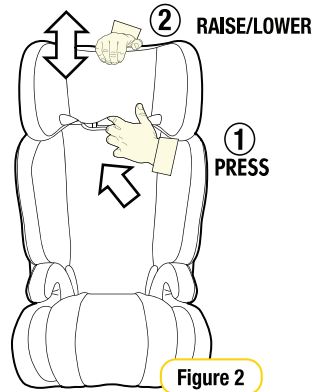
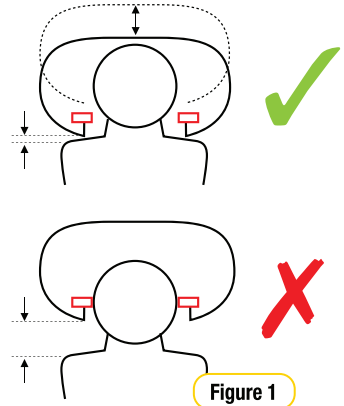
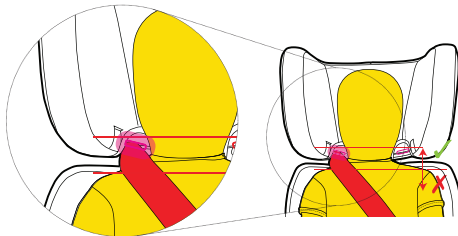



## Use

### Using lap-sash seat belt

**Step 1:** Ensure the restraint has been installed as per "INSTALLING IN VEHICLE" on Page 11 (refer Figure 1).

**Step 2:** Sit your child in the restraint with their back against the backrest (refer Figure 2).

#### **IMPORTANT**

Ensure that you use the **BOOSTER BELT PATH** identified by the following label.



**Step 3:** Position the lap section of the vehicle seat across the child's lap then insert the buckle tongue in to the belt buckle until you hear "CLICK". Ensuring the lap portion is positioned under the armrests and over the child's thighs (refer Figure 3).

The red "Booster Seat Belt Path" labels are located each side of the Booster seat and on the head rest.

#### **WARNING**

- DO NOT USE WITH JUST A LAP BELT. You must use a lap-sash seat belt.



Figure 1



Figure 2



Figure 3

## Use

### Using lap-sash seat belt

**Step 6:** Pull the lap belt tight by first pulling on the lap belt in the direction of arrow 1 (refer Figure 4). Pull the sash belt tight in the direction of arrow 2.

**WARNING**  
 • ALWAYS USE THE SASH

### Safe Grip (if supplied)

\*Can be purchased separately visit <http://store.infasecure.com.au/>

#### SAFE GRIP BELT CLAMP

It is important that the lap belt must be firmly across the thighs. The Safe Grip locks the lap belt to ensure a firm fit across the thighs, and avoids slack in the lap belt. This fit ensures that the lap belt does not ride up into the soft abdominal region of the child, which may cause internal injury.

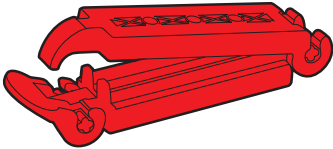

To install the Safe Grip (red belt clamp);

Continue from Step 6: while holding the belts tight, open the Safe Grip and clamp the “sash section” of the vehicle seat belt by closing the barrel section of the red belt clamp in the direction of arrow 3 (refer Figure 5). Then locking with the toggle section by pushing in the direction of arrow 4 (refer Figure 5) Note: Positioned as close as possible to the buckle and tongue. When the Safe Grip (red belt clamp) is secured in place, the lap section is now tightly holding your child in place, independent of the sash section.

The Safe Grip (red belt clamp) can be left located on the sash belt when the child is removed from the booster. It is then ready for the next use. Repositioning of the Safe Grip (red belt clamp) may be required as the child grows. The Safe Grip (red belt clamp) must be removed when the child restraint is not installed to allow other users to use the seat belt as a lap/sash seat belt. Always keep the Safe Grip (red belt clamp) in pocket provided when not in use.



Figure 4

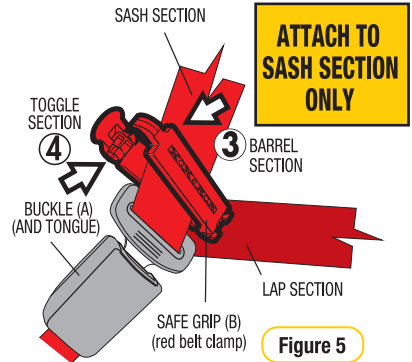

Figure 5

## Use

### Using lap-sash seat belt

**Step 7:** Pass the shoulder belt through the belt sash guide (refer Figure 6) which is moulded in the side wings of the headrest. Ensure the headrest is positioned as per "Adjusting the Headrest" (see Page 13).

#### **WARNING**

- **DO NOT LEAVE CHILDREN UNATTENDED IN THE CAR**
- Fit the seat belt firmly to the child.
- **ALWAYS USE THE SASH GUIDE**

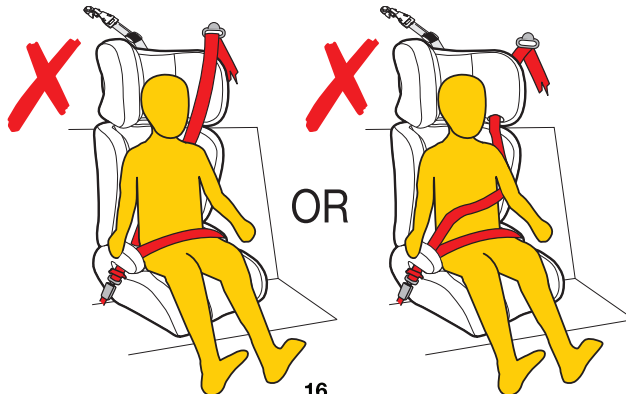

Figure 6

### Safety Warning

#### **WARNING**

**A SASH BELT UNDER THE ARM OR BEHIND THE BACK IS DANGEROUS**



## Use

### To release child

**Step 1:** To release your child from the booster seat simply press the belt buckle and carefully remove your child from the seat.

If using a Safegrip (red belt clamp)  
It is not necessary to release the red belt clamp, to remove your child (if applicable).

**Note:** When the restraint is not in use, the seat belt should be fastened around it and engaged.



### WARNING

- Always use lap-sash seat belt and upper anchorage strap to attach the child restraint to the vehicle.
- Do not use the restraint without the upper anchorage strap correctly attached and adjusted.
- Do not use on any vehicle seat which faces sideways or rearwards.
- **IF AN AIRBAG IS FITTED IN THE SEATING POSITION WHERE THE CHILD RESTRAINT IS TO BE FITTED, FOLLOW THE VEHICLE MANUFACTURER'S WARNINGS AND INSTRUCTIONS.**
- **DO NOT USE WITH JUST A LAP BELT.** You must use with a lap-sash seat belt
- Ensure the lap belt is correctly positioned on the child's thighs and hips.
- Do not place the seat belt sash under the arm or behind the back of the child.

# Care of Restraint

The child restraint cover has been manufactured to meet the Australian Standards requirements for flammability and toxicity to ensure your child's safety. The cover has also been designed to provide your child with comfort and support.

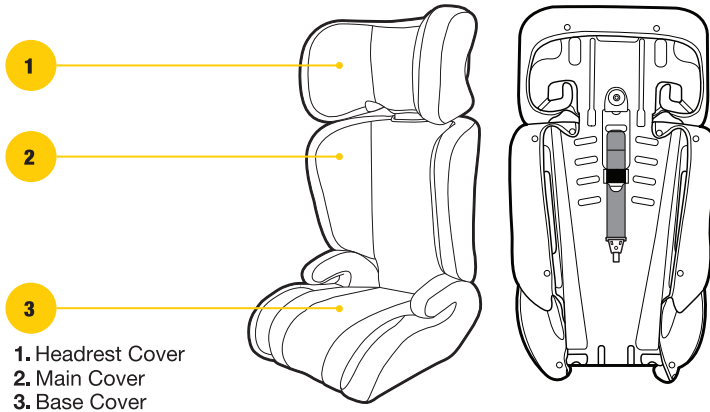

## **VERY IMPORTANT**

**Only replace the cover with a InfaSecure supplied replacement cover with identical shoulder height markers or a replacement cover meeting AS/NZS 8005.**

## Care and Maintenance

Regular care of the restraint will ensure safety of your child.

- Check the webbing for fraying.
- Check the upper anchorage attachment clip to ensure retainer clip is still present.
- Ensure there are no cracks in moulding or the plastic moulding.
- If any part of the restraint is cracked or broken, seek repair immediately or replace the child restraint.

# Cleaning



## IMPORTANT

Use only mild soap and water to clean all parts of the CS6213 Booster Seat.  
Do not use chemicals or cleaning agents  
Cold water only to be used and to be rinsed well  
Do not dry clean or tumble dry  
Do not bleach.

## Covers

The restraint has a flame retardant cover which is removable for cleaning. Cleaning instructions are on the care label attached to the cover. If a fluffy cover is fitted, then washing the cover prior to use will remove excess fluff.

The cover has been designed to protect your child when seated in the restraint. Care should be taken, if children either eat or drink while in the restraint, as some food or drink products may cause damage or marking to the cover. Wash or clean immediately. Do not pull sticky items from covers as the cover may be damaged - soak in water and gently remove.

Only machine wash on gentle cycle (hand washing is recommended). When washing the covers, ensure the hook and loop attachment strips are connected to eliminate other materials or garments being caught. Ensure that the hook and loop attachment strips are free of lint, this will ensure a positive engagement.

## Seat + Hardware

Use only mild soap and water to clean all webbing, metal and plastic parts of the restraint using a damp cloth.  
Do not use chemicals or cleaning agents.



# Remove & Replace Covers

## Main Cover

### To remove and replace covers

#### BASE COVER:

**Step 1:** Unclip the press studs and remove Base Cover.

#### BACKREST COVER:

**Step 1:** Unclip the press studs at the bottom of the cover

**Step 2:** Remove Backrest Cover.

**TO REPLACE COVER REVERSE THE ABOVE PROCEDURE.**

#### HEADREST COVER:

**Step 1:** Unclip the press studs and disconnect the two elastic loops located in the Sash Guides

# Extension Straps

If required contact InfaSecure for nearest supply location. Extension straps, not included in this package, may be required for vehicles without a fixed parcel shelf.

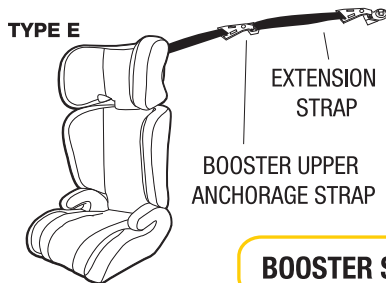

#### Re order Line Numbers

CS111 300mm Length

CS112 600mm Length

CS113 200mm - 900mm  
Adjustable Length

#### BOOSTER SEAT

If required contact InfaSecure  
Customer Care  
AU: 1300 92 4632  
NZ: 067 590 870  
for nearest supply location.

# Accessories

Follow the instructions covering the use of accessories provided with this child restraint or spare parts provided by InfaSecure for this restraint.

## **IMPORTANT**

Use of unauthorised aftermarket accessories (i.e items not provided in this box with the child restraint), can reduce the safety provided by the child restraint and may cause injury or death.

### **SEAT PROTECTOR** (if supplied)

The seat protector is designed to protect your car's seat.

#### **STANDARD**

**Step 1:** Position the front flap with pockets, at the front of the rear seat and position the mat rearwards to obtain a flat fit.

#### **FULL LENGTH**

**Step 1:** Position the front flap with pockets, at the front of the rear seat and position the mat rearwards to obtain a flat fit. (If required an additional flap has been provided to tuck in between the seat back & cushion)

**Step 2:** Position the back section up the seat back and use the plastic buckle & webbing strap to attach around the vehicle seat headrest (if the rear vehicle seat does not have a headrest then the strap could be used to attach around the child seats top tether after you have installed the child seat).

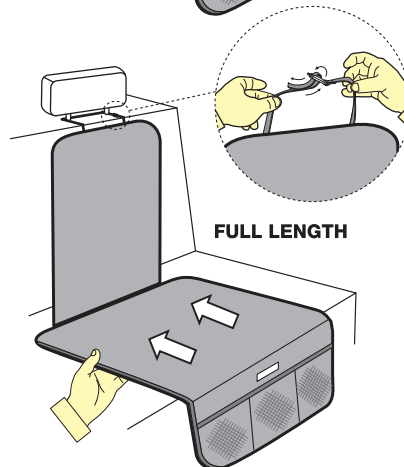
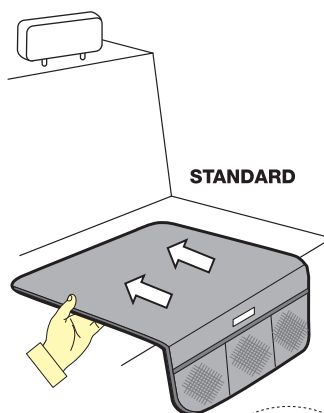



# Anchorage Fittings

Some vehicles may have an anchor fitting already fitted by the vehicle manufacturer.

If no anchorage points can be found refer to the vehicle manufacturer, or an authorised child restraint fitting station for the best location of an anchorage point.

Refer to the vehicle owners handbook or child restraint fitting station for the possible use of spacers.

Some vehicles may require the use of additional extension straps (not supplied with this child restraint)

If so ring InfaSecure on AU: 1300 92 4632  
 NZ: 067 590 870 for nearest supply location.  
**ADDITIONAL EXTENSION STRAPS AVAILABLE:**  
 CS111 300mm Extension strap  
 CS112 600mm Extension strap  
 CS113 200 - 900mm Adjustable Extension strap



## WARNINGS

- Top tether strap and attachment clip must always be used
- Always ensure that the upper attachment clip is correctly engaged to the anchor fitting
- **THIS RESTRAINT MUST BE ATTACHED TO A CHILD RESTRAINT ANCHORAGE POINT IN THE CAR. REFER TO CAR OWNER'S HANDBOOK FOR LOCATION OF ANCHORAGE POINTS. REFER TO A CHILD RESTRAINT FITTING STATION IF NO CAR ANCHORAGE POINTS ARE IN THE MOTOR CAR.**
- **THIS RESTRAINT IS NOT SUITABLE FOR USE WHERE TOP TETHER STRAP MAY FALL INTO A SPLIT IN THE SEAT BACK OR OFF THE SIDE OF THE SEAT.**

## For cars fitted with a child restraint anchorage point

THIS RESTRAINT MUST BE ATTACHED TO A CHILD RESTRAINT ANCHORAGE POINT IN THE CAR. LOCATE THE ANCHORAGE POINT BEHIND THE REAR SEATING POSITION CONSULT THE CAR OWNER'S HANDBOOK FOR LOCATION OF ANCHORAGE POINTS. REMOVE THE THREAD PLUG FROM THE PARCEL SHELF/FLOOR/ROOF AND INSTALL THE ATTACHMENT BOLT AS SHOWN IN FIGURE 1A & 1B.

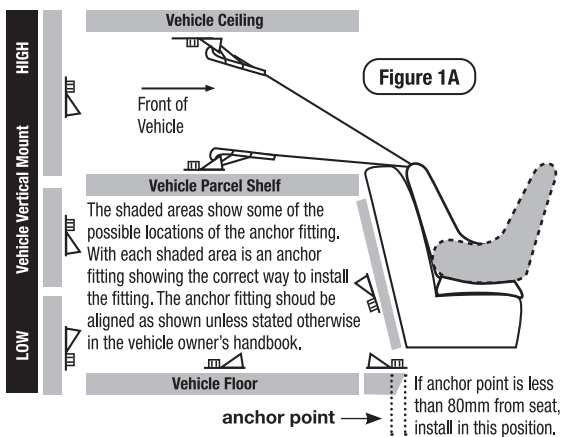

**CAUTION: DO NOT OVERTIGHTEN ATTACHMENT BOLT. MAXIMUM TORQUE IS 20NM.**

**WARNING: If A.D.R. anchorage point is recessed, spacer(s) may be required. Spacer Part No's are as follows:**  
 10mm - CCS001;  
 5mm - CCS002

### UPPER ANCHORAGE FITTINGS

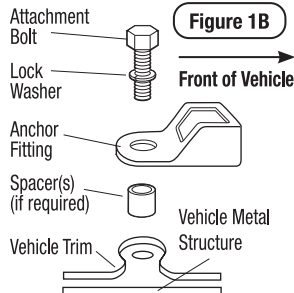

# Anchorage Fittings

## For cars not fitted with a child restraint anchorage point

### For Sedans Only

Drill a 9mm diameter hole in the parcel shelf on the centre line of the seating position as shown in Figure 1C. Hole must be no closer than 200mm from the front of the back seat. Install the anchor bolt as shown in Figure 1D.

Note to Queensland purchases: The installation of anchorage points must be approved by authorised officers appointed by Queensland Transport. Authorised officers can be sourced from all Queensland Transport Customer Service and Queensland Ambulance Service Centres.

### For Vehicles other than Sedans

In Australia, consult your nearest child restraint fitting station of traffic authority for vehicle inspection to find the best, correct position for the placement of the anchorage point, and for the correct attachment bolt length use of spacers.

In New Zealand consult the agent of the vehicle.

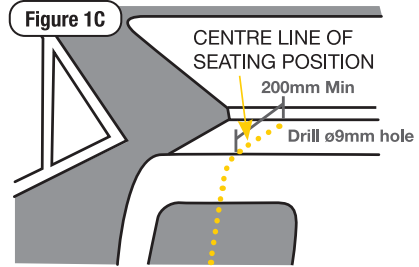

## ⚠ WARNINGS

CHILD RESTRAINTS MUST NOT BE ATTACHED TO UNSOUND METAL OR WOOD OR SYNTHETIC STRUCTURES. WHEN DRILLING THE 9MM HOLE DO NOT DRILL THROUGH FUEL LINES, FUEL TANKS, ELECTRICAL WIRING OR RADIO SPEAKERS. WEBBING STRAPS MUST BE PROTECTED FROM SHARP CORNERS AND EDGES.

THE ANCHOR FITTING MUST BE USED ONLY AS DESCRIBED ABOVE. IT MUST NOT BE HOOKED ONTO ANY OTHER OBJECT.

### UPPER ANCHORAGE FITTINGS FOR SEDANS ONLY

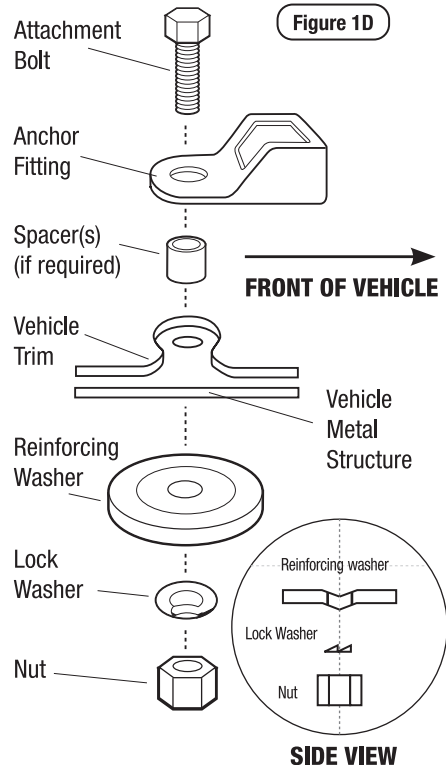

# Insurers Information

If your restraint has been involved in a severe crash, you should destroy the restraint even if no damage is obvious. Some insurance companies offer vehicle insurance which covers or partially covers the replacement of your child restraint. Contact your insurance company for further details. Your insurance company may require you to keep the child restraint for assessment, but do not use the child restraint after a severe crash. To assist you in making an accident insurance claim cut the following statement and include it with your claim.

## NOTICE TO INSURANCE COMPANY CHILD RESTRAINT INVOLVED IN AN ACCIDENT

All InfaSecure child restraints are manufactured to Australian/New Zealand Standards AS/NZS1754 which requires us to advise users of child restraints to "Destroy the entire restraint if it has been in use in a severe crash, even if no damage is obvious".

The Australian/New Zealand Standards committee, advise that this statement applies whether a child was in the child restraint or not. We consider a "severe crash" as being one where the main body structure of the vehicle is distorted.

There is no method of determining if the restraint has been damaged and we concur with the Australian/New Zealand Standards in recommending destruction of the child restraint.

This notice is to advise you of the requirements of the Australian/New Zealand Standards and our obligation in complying with the standards.

Please assist the owner of this restraint in their claim.

**INFASECURE PTY LTD** ABN: 52 149 173 660

Head Office and Registered Address  
110-114 Old Bathurst Rd, Emu Plains, NSW 2750  
P.O. Box 487, Emu Plains, NSW 2750

CUSTOMER CARE

**AU:** 1300 92 4632 **NZ:** 067 590 870 **Email:** [customercare@infa.com.au](mailto:customercare@infa.com.au)

 [infasecure.com.au](http://infasecure.com.au)  [facebook.com/infasecure](https://facebook.com/infasecure)  
 [instagram.com/infasecure](https://instagram.com/infasecure)  [youtube.com/infasecure](https://youtube.com/infasecure)









# LIFETIME WARRANTY

ON SUPER STRONG BLOW MOULDED SHELL PRODUCTS

Register your product to receive **lifetime warranty\***, product updates and information.

 Please visit [infasecure.com.au/warranty-registration](https://infasecure.com.au/warranty-registration) to register your product.

## **Infasecure Warranty**

Infasecure Pty Ltd warrants this product for twelve months from the date of purchase against failure due to manufacturing faults or faulty materials. Misuse, accidental damages, normal wear and tear are not covered by this warranty.

When used for commercial use the period is limited to six months. "Our goods come with guarantees that cannot be excluded under the Australian Consumer Law. You are entitled to a replacement or refund for a major failure and for compensation for any other reasonably foreseeable loss or damage. You are also entitled to have the goods repaired or replaced if the goods fail to be of acceptable quality and the failure does not amount to a major failure."

## **Additional Warranty on Blow Moulded Child Restraints**

Our blow moulded child restraints are covered against faulty materials and manufacturing when used under normal conditions and according to the instructions.

In the unlikely case that you do have a fault in relation to material quality or manufacturing that restricts your ability to use your Child Restraint normally, we will repair or replace the product within the following warranty periods from date of purchase:

- 12 month warranty for material and fabrics
- 2 year warranty for straps and webbing
- 5 year warranty for hardware and fittings
- Lifetime warranty\* on the manufacturing of the seat moulding

Please read your instruction manual carefully before using any of our products. The above express warranties do not apply where a failure or defect results from improper care, misuse or from normal wear and tear.

Refer to website for more details: [www.infasecure.com.au](https://www.infasecure.com.au)

\*Lifetime warranty refers to the life span of the seat which is 10 years from the Date of Purchase.



CHILD RESTRAINT SAFETY PARTNER



“ We are proud to be working with The Wiggles. With their help, we are able to reach more young families with much needed information and advice to keep our little ones safe. ”

**INFASURE PTY LTD** ABN: 52 149 173 660

Head Office and Registered Address  
110-114 Old Bathurst Rd, Emu Plains, NSW 2750  
P.O. Box 487, Emu Plains, NSW 2750

CUSTOMER CARE

**AU:** 1300 92 4632 **NZ:** 067 590 870 **Email -** [customer care@infa.com.au](mailto:customer care@infa.com.au)

[infasure.com.au](http://infasure.com.au) [facebook.com/infasure](https://facebook.com/infasure)

[instagram.com/infasure](https://instagram.com/infasure) [youtube.com/infasure](https://youtube.com/infasure)



**Australian  
Standard**

AS/NZS: 1754:2013  
Licence No. 25324-2  
SAI Global

**ISSUE: C**