

Convertible Booster Seat

CHILD SEAT TO BOOSTER SEAT
CS7113 / CS7213



CHILD CAR SEAT



BOOSTER SEAT

Child Car Seat: Suitable for children from 6 months to approximately 4 years* of age.
Boosters Seat: Suitable for children from 4 years to approximately 6 to 8 years* of age.

Instruction Manual

IMPORTANT: KEEP THIS BOOKLET IN THE PLACE PROVIDED ON THE CHILD RESTRAINT

*All references to age are approximates only and reference to children of average proportions. Children vary in shapes and sizes. The photo displayed is indicative of the type of restraint and may vary slightly depending on the model.



Australian Standard

AS/NZS: 1754:2013
Licence No. 25324-1
SAI Global

Contents

Contents	1
Information	2
Warnings	3
Restraint Guide	5
Padding - Combination Guide	6
Child Car Seat	
Information	7
CS7113 / CS7213 Child Restraints (Itemised list)	8
Shoulder Height Marker	9
Set Up	
- Selection of Appropriate Padding Combination	11
- Adjusting Recline Angle	11
- Shoulder Height	11
Installation	
- Installing using Vehicle seatbelt	13
Use	
- Using Inbuilt Harness	17
- To Release Child	19
Booster Seat	
Information	20
Shoulder Height Marker	21
CS7113 / CS7213 Child Restraints (Itemised list)	23
Next Restraint	24
Set Up	
- Selection of Appropriate Padding Combination	25
Installation	
- Converting to a child booster	25
- Adjusting Recline Angle	27
- Installing using Vehicle seatbelt	27
Use	
- Using Seatbelt	29
- To Release Child	32
Care of Restraint	
- Care and Maintenance	33
- Cleaning	34
Remove & Replace Covers	36
Extension Straps	37
Accessories	37
Anchorage Fittings	41
Insurers Information	43
Lifetime Warranty	46

Please read carefully the whole of the instructions for installation and, in the event of doubt about the method of installation, to consult InfaSecure or agent, or a child restraint fitter, or in New Zealand, to consult the agent for the vehicle.

Information

This instruction manual covers various models under the Model number CS7113 / CS7213. This Convertible Booster Seat is designed to be used by children from approximately 6 months of age up to approximately 8 years of age. These are installed in the back seat of the vehicle using the vehicle seatbelt & the top tether strap.

Air Cocoon Technology™ - A Protective Embrace

Air Cocoon Technology™ (A.C.T.) enhances protection by dramatically reducing the impact forces during a crash. A.C.T. utilises a layer of air held inside the entirety of the child restraint shell, offering an increased level of protection across the entire surface area of the restraint. Your child is quite literally cradled in a cocoon of air, offering a true 180 degrees of protection to your child's vital organs.

Air Cocoon Technology™ integrated child restraints start their life as an actual pillow of air. This pillow is moulded into a child restraint, retaining the pillow-like construction while adding incredible strength and structural integrity. This manufacturing process is called blow-moulding.

Air Cocoon Technology™ (A.C.T.) is an all encompassing protective 'cocoon' around your child.



Child Restraints

No child restraint can guarantee absolute protection from injury in every crash. However, to ensure that your child gets all the protection designed into the restraint please read and follow the instructions exactly and use only InfaSecure recommended parts and accessories.

Family Business

InfaSecure is an Australian owned and operated family business, which can trace its roots back over 60 years in business, becoming the single largest Australian owned and operated child restraint company in the country. Today, we are still growing, continuing to innovate and provide high quality products at an affordable price.



Warnings



WARNINGS

- Use the restraint exactly as shown in the instructions.
- Supervision of children is needed because they may be able to undo buckles.
- **DO NOT LEAVE CHILDREN UNATTENDED IN THE CAR.**
- Do not alter or modify this restraint.
- Repairs must only be done by the manufacturers or agent.
- Do not allow the restraint to come into contact with polishes, oils, bleach and other chemicals.
- Destroy the restraint if it has been in a severe crash, even if no damage is visible.
- **DO NOT USE THIS RESTRAINT WITHOUT THE COVER.**
- Fit the restraint firmly to the car seat.
- Fit the harness firmly to the child.
- A loose restraint or harness is dangerous.
- **DO NOT USE WITH JUST A LAP BELT.** You must use a lap-sash seatbelt.
- The lap part of the seatbelt must be firmly across the thighs and the sash belt fitted diagonally across the chest and on the shoulder.
- Always secure the loose end of the top tether strap. Do not use the child restraint where this strap may fall into a split in the seat back or off the side of the seat.
- **ALWAYS ATTACH HOOK AND REMOVE SLACK.**

Warnings



WARNINGS

- THIS RESTRAINT IS NOT SUITABLE FOR USE WHERE THE TOP TETHER STRAP MAY FALL INTO A SPLIT IN THE SEAT BACK OR OFF THE SIDE OF THE SEAT.
- THIS RESTRAINT MUST BE ATTACHED TO A CHILD RESTRAINT UPPER ANCHORAGE POINT IN THE CAR. REFER TO CAR OWNER'S HANDBOOK FOR LOCATION OF ANCHORAGE POINTS. REFER TO A CHILD RESTRAINT FITTING STATION IF NO ANCHORAGE POINTS ARE IN THE MOTOR CAR.
- Always secure the loose end of the top tether strap to prevent it hanging out of the car or being accessible by the child.
- Do not use the child restraint where this strap may fall into a split into the seat back or off the side of the seat.
- IF AN AIRBAG IS FITTED IN THE SEATING POSITION WHERE THE CHILD RESTRAINT IS TO BE FITTED, FOLLOW THE VEHICLE MANUFACTURER'S WARNINGS AND INSTRUCTIONS.















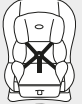



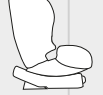

WARNING

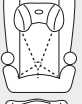
DO NOT LEAVE CHILDREN UNATTENDED IN THE CAR.

This child restraint is not approved for use with any connectors that connect to the car's isofix low anchorages

Restraint Guide

MODE	Infant Seat		Child Seat		Booster Seat			Seat Belt	
	BIRTH	2	4	6	7	8	10	12+	
REARWARD-FACING RESTRAINT (TYPE A1) BIRTH TO APPROX 6 MONTHS 	REARWARD FACING		0 to 6 (months)						
CONVERTIBLE CAR SEAT (TYPE A2/B) BIRTH TO 4 YEARS 	REARWARD FACING	FORWARD FACING	Approx 0 to 4 years						
CONVERTIBLE CAR SEAT (TYPE A4/B) BIRTH TO 4 YEARS 	REARWARD FACING	FORWARD FACING		Approx 0 to 4 years					
CONVERTIBLE CAR SEAT (TYPE A4/G) BIRTH TO 8 YEARS 	REARWARD FACING	FORWARD FACING				FORWARD FACING	Approx 0 to 8 years		
ZERO TO 8 CONVERTIBLE CAR SEAT (TYPE A1/B/E) BIRTH TO 8 YEARS 	REARWARD FACING	FORWARD FACING		BOOSTER SEAT			Approx 0 to 8 years		
FORWARD-FACING RESTRAINT (TYPE B) APPROX 6 MONTHS TO 4 YEARS 	FORWARD FACING		Approx 6 months to 4 years						
FORWARD-FACING RESTRAINT (TYPE G) APPROX 6 MONTHS TO 8 YEARS 	FORWARD FACING						Approx 6 months to 8 years		
CONVERTIBLE BOOSTER SEAT (TYPE B/E) APPROX 6 MONTHS TO 8 YEARS 	FORWARD FACING		BOOSTER SEAT				Approx 6 months to 8 years		
BOOSTER SEAT (TYPE E) FROM APPROX 4 YEARS TO 8 YEARS 	Approx 4 years to 8 years			BOOSTER SEAT		LARGER BOOSTER SEAT			
BOOSTER SEAT (TYPE F) FROM APPROX 4 YEARS TO 10 YEARS 	Approx 4 years to 10 years			BOOSTER SEAT					
SEAT BELT FROM APPROX 7 YEARS AND OVER 							7 +	10 +	

REQUIRED BY LAW

Allowable by law More Appropriate

IMPORTANT: Research has shown that the likelihood of an accessory child safety harness being used incorrectly is very high and the risk of injuries when incorrectly used is much higher compared to a lap-sash seat belt. InfaSecure recommend that an accessory child safety harness should only be used if a lap-only seat belt is all that is available.

Padding / Inserts

Combination Guide

STANDARD

(Shoulder pads & buckle pads)

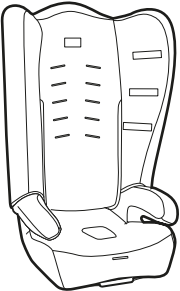
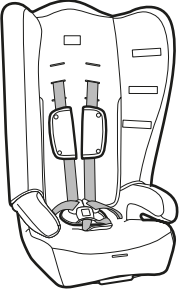
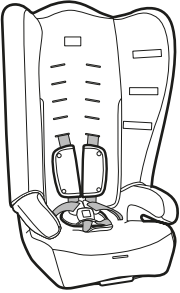

DELUXE

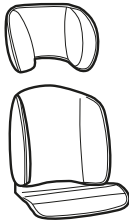

MODE

CHILD SEAT
(Small Child)

FORWARD FACING



CHILD SEAT
(Larger Child)

FORWARD FACING



BOOSTER SEAT

FORWARD FACING



The Padded Insert/s (if fitted) are designed to provide extra support and comfort for small children. Discontinue use when the insert is a tight fit or creates discomfort for larger children.

- Diagrams are indicative of type of paddings and inserts and may not resemble the actual product.
- Padded inserts can vary according to model.
- We reserve the right to alter this product without notice.

*For detailed description and method of attachment for padded accessories refer to Accessories on page 36.

Child Car Seat (Forward Facing)

THE SUITABILITY OF THE CHILD RESTRAINT TO GROUPS OF CHILDREN

TYPE B

To be used in a forward-facing position with built-in harness by a child whose shoulders are above the lower shoulder height marker (approximately 6 months of age). Until their shoulders reach the middle shoulder height marker (approximately 4 years of age).

TYPE E

Then to be used with a lap-sash seat belt until the child's shoulders reach the upper shoulder height marker (approximately 6 to 8 years of age).

Continue to use this child restraint until the child shoulders reaches this limit. Children are safest in a booster seat until their shoulders reach the upper shoulder height marker of the booster.

Do not use this child restraint until the child's shoulders are above the lower shoulder height marker.

A child restraint could be adjusted or installed such that the level of protection offered is reduced. Ensure that you follow these instructions to ensure the desired level of protection is achieved.

Children who have outgrown this restraint are safest in a larger child restraint with an in-built harness or a booster seat until their shoulders reach the upper shoulder height marker of the restraint.

TO BE USED WITH A LAP-SASH/LAP-ONLY SEATBELT IN THE BACK OF MOST CARS WITH FORWARD FACING SEATS.

The use of child restraints in the front seat may be restricted for children of specific ages by local legislation. Please check with your local Department of Transport for the specific seating locations of children using child restraints for their given ages.

IMPORTANT

- For a vehicle without a fixed parcel shelf an extension strap(s) may be needed. If so ring (02) 4728 8080 for nearest supply location.
- Seatbelt extenders are not recommended to be used if the seatbelt is not long enough to secure the child restraint. If seatbelts are too short then advice should be sought from a child restraint fitter and their recommendation be considered before using a seatbelt extender.

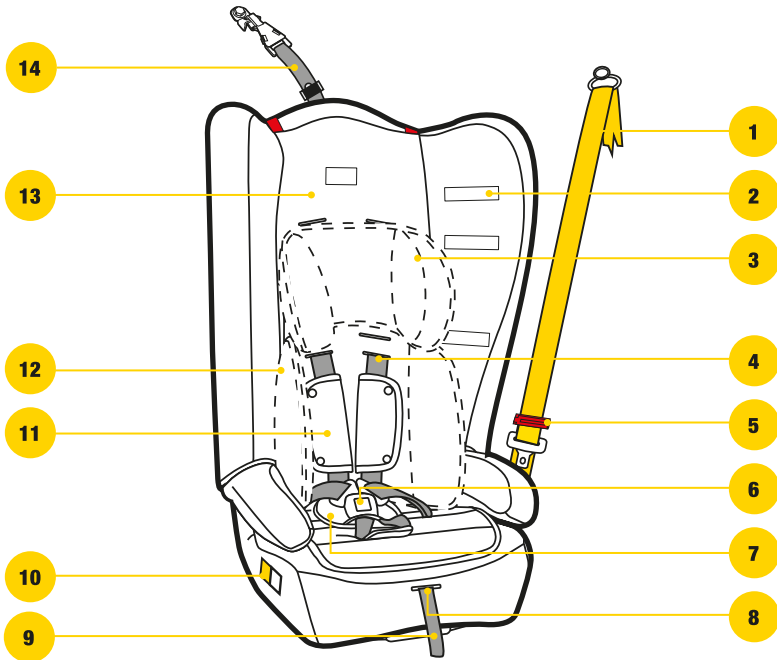

- | | |
|--|---|
| <ul style="list-style-type: none"> 1. Vehicle Seatbelt 2. Shoulder Height Markers 3. Pillow (if fitted) 4. Harness Strap 5. SAFE GRIP Red Belt Clamp (if applicable) 6. Buckle 7. Buckle Pad 8. Adjuster 9. Adjuster Strap | <ul style="list-style-type: none"> 10. SEAT BELT PATH™ Marker
(each side of restraint - coloured yellow) 11. Shoulder Pads 12. Comfort Insert (if fitted) 13. Comfort Cover
• Backrest • Seat Base 14. Top Tether Assembly
• Tether Strap
• Adjuster
• Attachment Clip
• Anchor Fitting + Attachment Hardware |
|--|---|

! IMPORTANT

- For a vehicle without a fixed parcel shelf an extension strap(s) may be needed. If so ring (02) 4728 8090 for nearest supply location. (Refer page 49)
- Seat belt extenders should not be used if the seat belt is not long enough to secure the child restraint.

Shoulder Height Marker

Smaller Toddler (using inbuilt harness)

Shoulder height markers are provided on this restraint for a visual indication that the child is safe to travel in this restraint. *Shoulder height markers may be hidden under a pillow in the lowest position.*

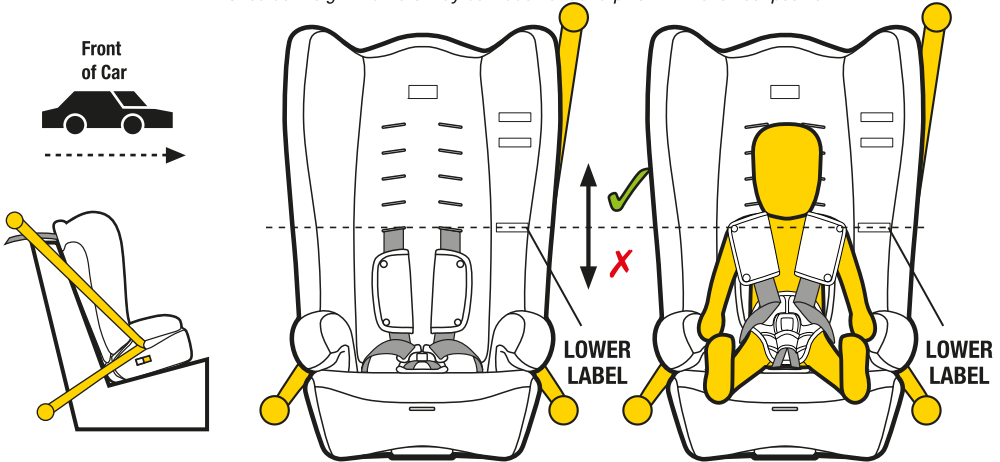

Smaller Child from approximately 6 months of age

Do not use as a forward-facing child restraint until the child's shoulders are **ABOVE** the Lower shoulder height marker (Lower label).

LOWER LABEL

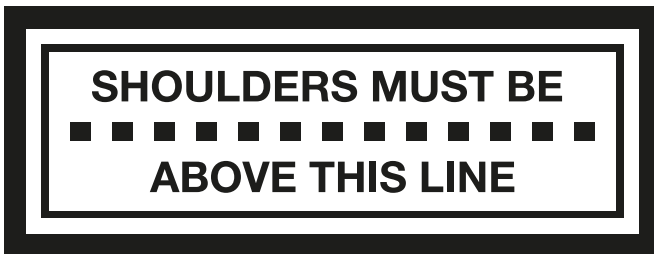

IMPORTANT

When using the inbuilt harness the child's shoulders must be in-line or **above** this marker

If moving a child from rearward-facing child restraint, to forward facing child restraint the child's shoulders will need to be in-line or above the lower label. If the child's shoulders are below the lower label or if the baby's neck muscles are unable to support their head, then the child should remain rearward-facing.

Shoulder Height Marker

Taller Toddler (using inbuilt harness)

Shoulder height markers may be hidden under a pillow in the lowest position

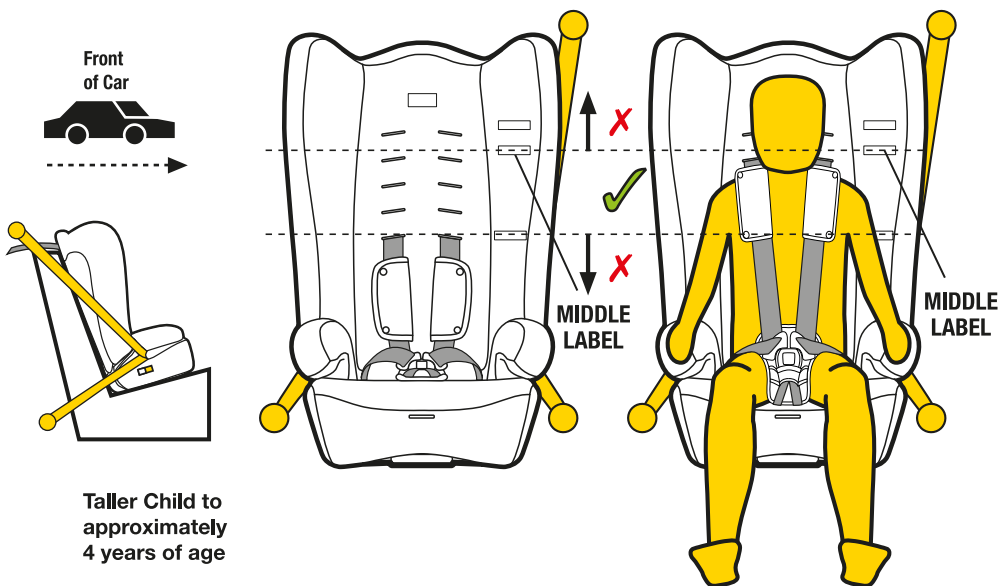

Taller Child to approximately 4 years of age

Continue to use this forward-facing child restraint until the child's shoulders **REACH** the Middle shoulder height marker (Middle Label).

MIDDLE LABEL (Forward-Facing)

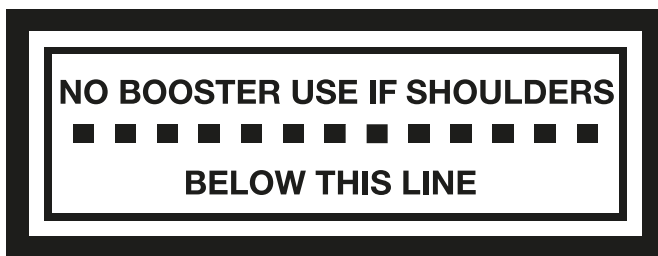

IMPORTANT

When the child's shoulders reach the shoulder height marker (Middle Label), convert the child restraint to booster seat mode and use with a lap sash seat belt.

Children are at risk of serious injury if they move to booster seats too early.

Children that have outgrown the forward-facing child restraint are safest in a booster seat until their shoulders reach the upper shoulder height marker of the booster seat.

Set Up

Selection of appropriate padding combinations

Step 1: Determine whether your child requires the additional padding provided with this restraint, to ensure a safe and snug fit in the restarint. Refer to page 6 for suggested padding combinations.

Adjusting Recline Angle (CS7213 Models Only)

Determine which seat angle is preferred for the comfort of your child.

TO RECLINE

Pull down the recline base and ensure the support is forward (in position).

***Model CS7113 has no recline feature.**

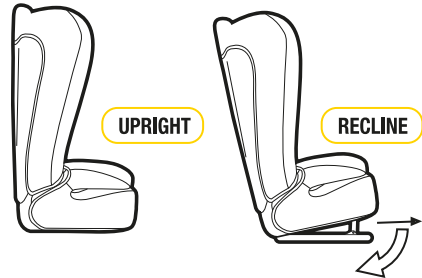

Correct shoulder height

The correct height for the shoulder straps is very important for the optimum performance of the restraint. The shoulder strap slots used in forward facing position are the upper and middle positions.



IMPORTANT

The shoulder straps must be in the slots which are nearest to the child's shoulders, but not more than 25mm below the child's shoulders.

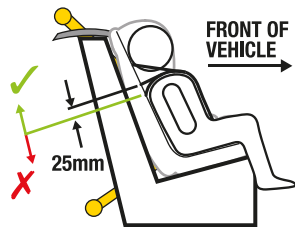

The shoulder strap slots used in Child Seat mode are above the lower shoulder height markers (refer Pages 29 & 30).

Shoulder Slot Height

With the child correctly sitting in the restraint, check which set of slots (in the plastic shell of the restraint) are the level with but not more than 25mm below the child's shoulders.

Step 1: From the rear of the restraint, remove each shoulder harness through the gates in the "G" connecting plate (see Figures 1, 2, 3 & 4).

Step 2: Pull the shoulder harness straps through the shoulder slot holes in the seat body and cover. They are now loose in the front of the seat (see Figure 5).

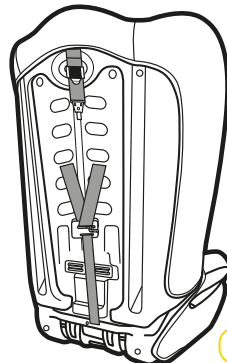

Figure 1

Setup

Shoulder Slot Height

Step 3: Push the ends of the shoulder harness straps through the appropriate shoulder slot holes in the cover and seat body for the child's shoulder height. (see above for correct shoulder height for forward facing).

Step 4: Thread each shoulder harness strap back onto the "G" connecting plate through the gate (see Figure 3). The shoulder harness straps are connected to the "G" connecting plate (see Figure 2).



IMPORTANT

- Do not use the restraint with harness shoulder straps set at different heights.
- Ensure that all straps have been secured correctly by pulling on each strap.
- Ensure that the harness straps are not twisted.
- Always adjust the height of the shoulder straps as the child grows.

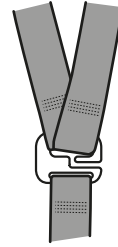

Figure 2

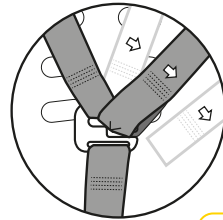

Figure 3

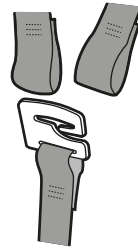

Figure 4

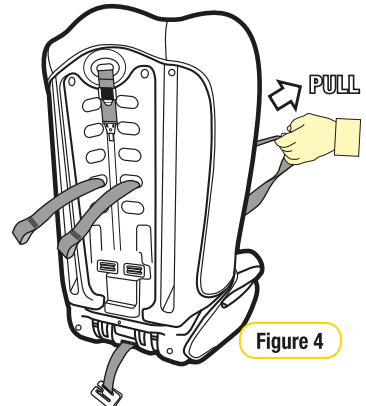

Figure 4

Installation

Installing Using Vehicle Seatbelt

Step 1: Place the restraint in desired upright or reclined position, with the back against the back of the vehicle seat, directly in line with the anchorage point (refer Figure 1).



IMPORTANT

Ensure that you use the
FORWARD-FACING BELT PATH
identified by the following label.

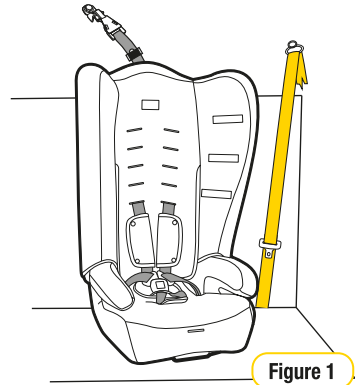

Step 2: Fold the rear of seat base cover and foam forward to expose the seating surface of the base (refer Figure 4).

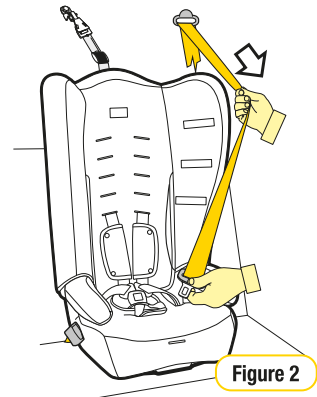

Fully extend the seat belt and pass the lap and sash sections of the vehicle belt under the first armrest, across the seat base ensuring you pass the seat belt beneath the tongue in the plastic moulding (refer Figure 4 & 5) then under the second armrest, “CLICK” the buckle tongue into the buckle (Refer to Figure 2, 3, 4 & 5).

Important notes: The vehicle belt is now located across the seat base. The belt path is shown by the arrows in Figure 4 & 5.

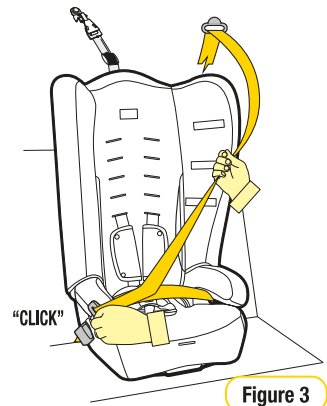

Installation

Installing Using Vehicle Seatbelt



IMPORTANT

Ensure that you use the **FORWARD-FACING BELT PATH** identified by the following label.

FORWARD-FACING BELT PATH

← **THREAD BELT BENEATH THIS TONGUE** →

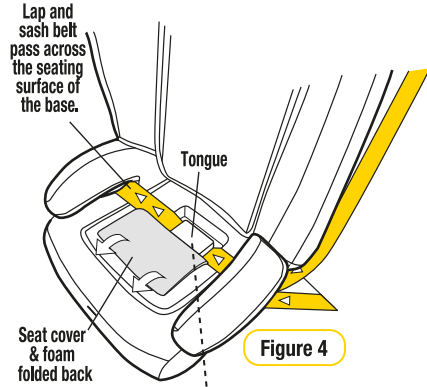
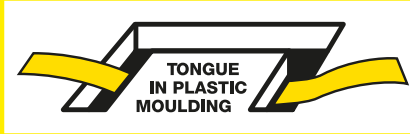

Figure 4

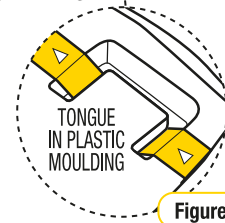

Figure 5

Step 3: Push down on the base of the restraint (with knee or hand) whilst pulling the sash section of the vehicle belt firmly up in direction of the yellow arrow in figure 6. This will make the lap belt very tight across the seat base. Whilst continuing to pull the sash section up (i.e maintaining tightness of the lap section). Tighten sash section of belt across the base (refer Figure 7).



WARNING

- Always use Top Tether strap to attach the child restraint to the vehicle.
- Do not use the restraint without the Top Tether strap correctly attached and adjusted.
- Do not use on any vehicle seat which faces sideways or rearwards.
- IF AN AIRBAG IS FITTED IN THE SEATING POSITION WHERE THE CHILD RESTRAINT IS TO BE FITTED, FOLLOW THE VEHICLE MANUFACTURER'S WARNINGS AND INSTRUCTIONS.
- Fit the restraint firmly to the car seat.

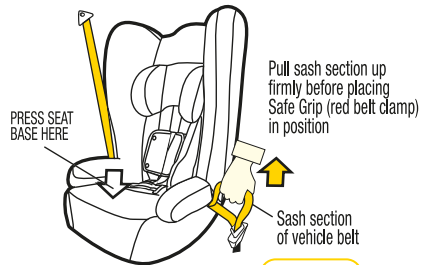
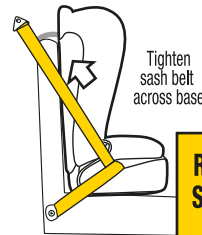

Figure 6



REMOVE ALL SLACK FROM SEATBELT

Figure 7

Installation

Installing Using Vehicle Seatbelt

Step 4: Place layer of foam and seat cover back into position over the top of the vehicle belt (refer Figure 8).

Safe Grip (if supplied)

*Can be purchased separately visit <http://store.infasecure.com.au/product>

SAFE GRIP BELT CLAMP

The **Safe Grip** (red belt clamp) **locks the lap belt** to ensure a firm installation, and avoids slack in the lap belt.

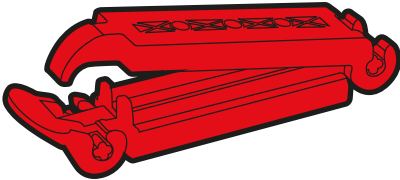

To install the **Safe Grip** (red belt clamp), open it and clamp the “sash section” **ONLY** of the vehicle seat belt by closing the barrel section of the red belt clamp in the direction of arrow 1 in Figure 5 and then locking with the toggle section by pushing in the direction of arrow 2 in Figure 5 when the **Safe Grip** (red belt clamp) is secured in place, the lap section is now tightly holding your child restraint in place, independent of the sash section. The **Safe Grip** (red belt clamp) must be removed when the child restraint is not installed to allow other users to use the seat belt as a lap/sash seat belt. Always keep the **Safe Grip** (red belt clamp) in pocket provided when not in use.

NOTE: Do not place the **Safe Grip** (red belt clamp) around both the lap and sash sections of the belt. This could cause the **Safe Grip** (red belt clamp) to break.

(Using Lap Seat Belt)

Step 1: Follow the instructions covered by “Installing in Vehicle (Using lap sash seat belt)” Steps 1 to 4 (refer pages 13 & 15).

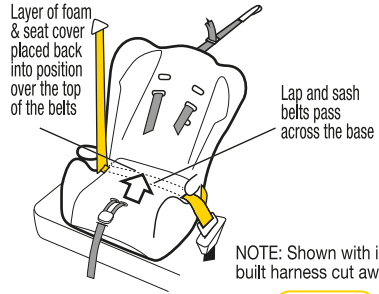

NOTE: Shown with in built harness cut away

Figure 8

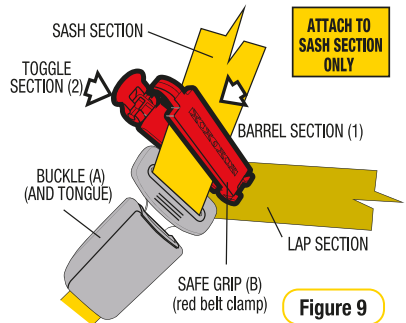
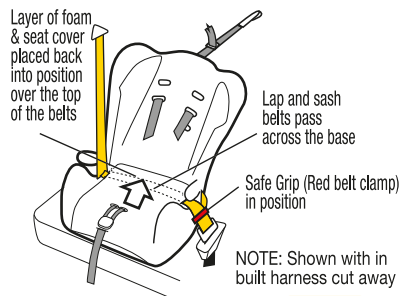

Figure 9



NOTE: Shown with in built harness cut away

Figure 10

Installation

Installing Using Vehicle Seatbelt

Note: If no upper anchorage fitting is available refer to Pages 40 & 41.

Step 5: Hook the attachment clip to the anchor fitting. Ensure there are no twists in the top tether strap (refer to Figure 11).

Step 6: Pull to tighten to remove all the slack, from the upper anchorage strap. Do not overtighten as this could cause the restraint to lift off the vehicle seat (refer to Figure 12).

Step 7: Roll up and store any excess webbing, from the top tether strap, in the storage pocket provided on the restraint (refer to Figure 13).

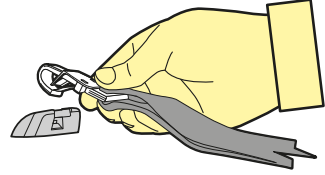

Figure 11

CAUTION: CHILDREN CAN BE INJURED OR RESTRAINTS AND TOP TETHER STRAP DAMAGED BY UNSECURED CARGO IN A COLLISION. SECURE OR REMOVE HAZARDOUS CARGO BEFORE USING THIS CHILD RESTRAINT.

Always secure the loose end of the top tether strap to prevent it hanging out of the car or being accessible by the child.

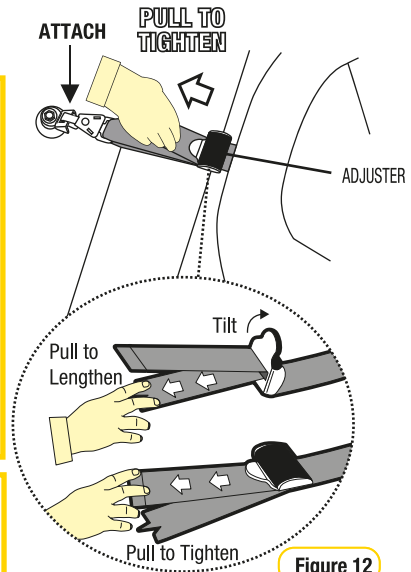

Figure 12

IMPORTANT

- Tighten till slack is removed.
- In certain vehicles an extension strap may be needed.
- Do not overtighten Top Tether strap.
- Ensure Top Tether strap is passed through the Top Tether Strap Guide.
- Always secure the loose end of the top tether strap to prevent it hanging out of the car or being accessible by the child.

Tether Storage

After correctly installing the restraint in your car, roll up and place any excess tether strap in the storage pocket provided (refer Figure 13).

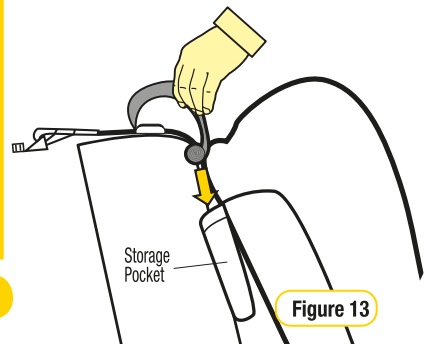

Figure 13

Use

Using Inbuilt Harness

Step 1: Ensure the restraint has been installed and set up as per "Set Up" and "Installation" (refer Page 11 - 16).

Step 2: To lengthen the harness "LIFT" the harness adjuster (refer Figure 1) whilst grasping both shoulder harness straps and pulling. Ensure shoulder straps are pulled equally on each side.

Step 3: Place child in car seat with legs either side of the buckle, place harness over the shoulders and hips. (refer Figure 2).

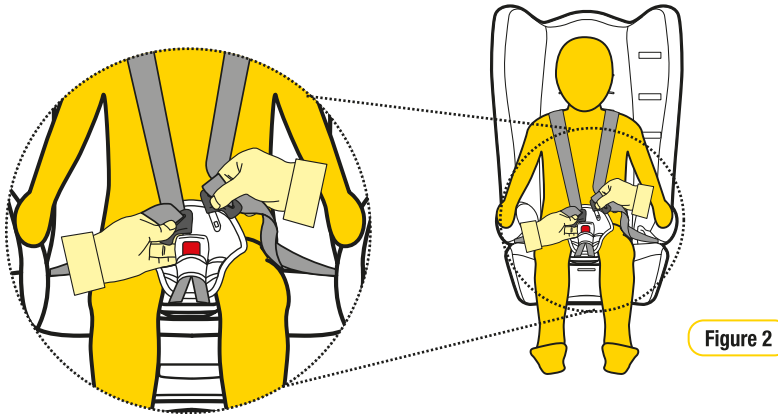
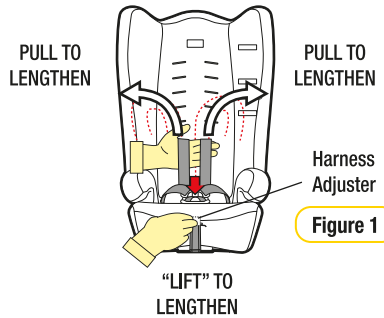

Use

Using Inbuilt Harness

Step 4: Insert either tongue into the buckle followed by the other tongue until a “CLICK” is heard. Should the second tongue not insert, press the red button and reinsert the tongues. Ensure secure engagement by pulling the harness strap (refer Figure 3).

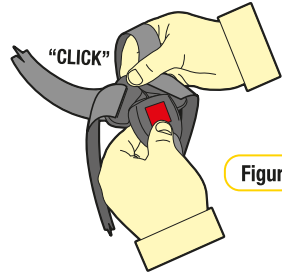
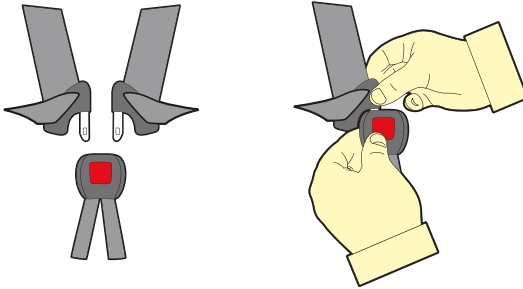

Figure 3



IMPORTANT

If no “Click” can be heard or a secure engagement cannot be achieved refer to Cleaning Buckle Harness page 42.

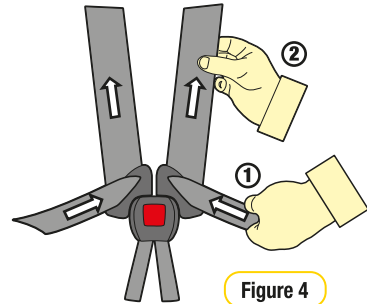

Figure 4

Step 5: Remove all of the slack for the harness lap straps by pulling shoulder straps (refer Figure 4), then pull the harness adjustment strap to adjust harness to a comfortable but firm fit (refer to Figure 4 & 5).



WARNINGS

- DO NOT LEAVE CHILDREN UNATTENDED IN THE CAR.
- Fit the harness firmly to the child.
- A LOOSE RESTRAINT OR HARNESS IS DANGEROUS.

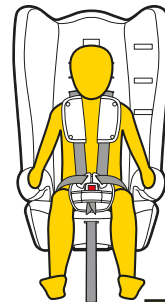

Harness Adjuster Strap

Figure 5

REMOVE ALL SLACK FROM HARNESS

Use

Using in-built harness

Step 9: Check the harness tightness by the **PINCH TEST**, this is achieved by pinching the harness webbing at the shoulders (refer Figure 6)

- If you can pinch the harness strap, tighten more.
- If your fingers slip off, then the harness is tight enough.



IMPORTANT

- A LOOSE HARNESS IS DANGEROUS.
- Always adjust the height of the shoulder straps as the child grows.

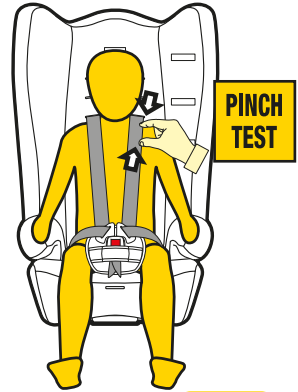

Figure 6

To Release Child

Step 1: To release your child from the restraint simply press the harness buckle and carefully remove your child from the restraint (refer Figure 1).

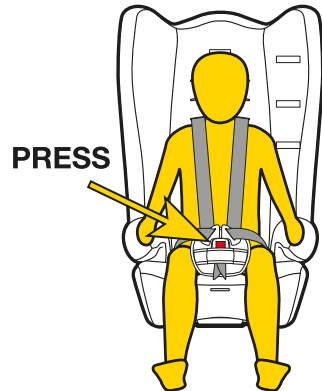

Figure 1

Booster Seat (Forward Facing)

THE SUITABILITY OF THE CHILD RESTRAINT TO GROUPS OF CHILDREN

TYPE E

To be used with a lap-sash seatbelt by a child whose shoulders are above the lower shoulder height marker (approximately 4 years of age) until the child's shoulders reach the upper shoulder height marker (approximately 6 to 8 years of age).

Continue to use this booster seat until the child reaches this limit. Children are safest in a booster seat until their shoulders reach the upper shoulder height marker of the booster seat.

Do not use this booster seat until child's shoulders are above the lower shoulder height marker.

A child restraint could be adjusted or installed such that the level of protection offered is reduced. Ensure that you follow these instructions to ensure the desired level of protection is achieved.

If the knees do not bend in front of the vehicle seat cushion continue to use a booster seat.

Just using a seatbelt is not recommended for children that have outgrown this seat. Use a larger booster seat.*

THIS RESTRAINT MUST BE USED IN CARS WITH FORWARD-FACING SEATS WITH A LAP-SASH SEATBELT. THIS BOOSTER SEAT IS NOT SUITABLE FOR USE WITH A CHILD HARNESS.

The use of child restraints in the front seat may be restricted for children of specific ages by local legislation. Please check with your local Department of Transport for the specific seating locations of children using child restraints for their given ages.



IMPORTANT

- For a vehicle without a fixed parcel shelf an extension strap(s) may be needed. If so ring (02) 4728 8080 for nearest supply location.
- Seatbelt extenders are not recommended to be used if the seatbelt is not long enough to secure the child restraint. If seatbelts are too short then advice should be sought from a child restraint fitter and their recommendation be considered before using a seatbelt extender.

Shoulder Height Markers

Smaller Child (using lap-sash seatbelt)

Shoulder height markers are provided on this restraint for a visual indication that the child is safe to travel in this restraint. *Shoulder height markers may be hidden under a pillow in the lowest position.*

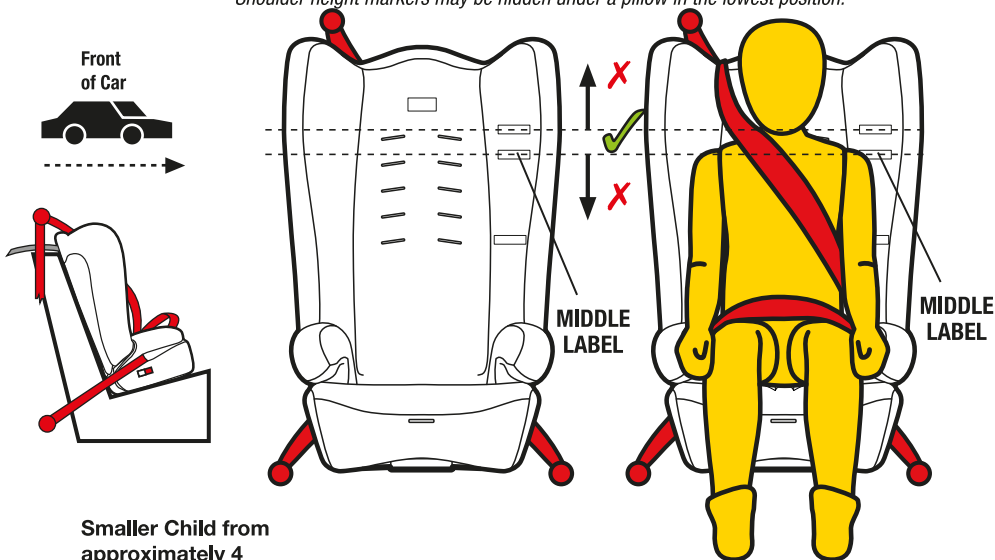

Smaller Child from approximately 4 years of age

Do not use as a booster seat until the child's shoulders are **ABOVE** the middle shoulder height marker (middle label).

MIDDLE LABEL (Forward-Facing)



IMPORTANT

When the child's shoulders reach the shoulder height marker (Middle Label), convert the child restraint to booster seat mode and use with a lap sash seat belt.

If moving a child from forward-facing child restraint, to a booster seat the child's shoulders will need to be in-line or above the middle label. If the child's shoulders are below the middle label, then the child should remain forward-facing using internal harness.

Shoulder Height Markers

Taller Child (using lap-sash seatbelt)

Do not continue to use the restraint if the child's shoulder are above the Upper Label.

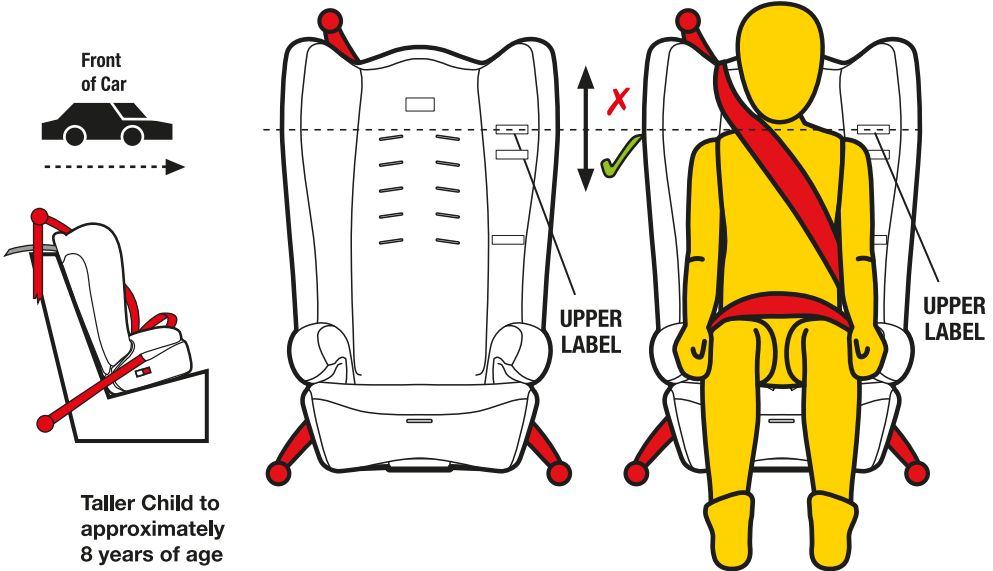

Continue to use this booster seat until the child's shoulders **REACH** the Upper shoulder height marker (Upper Label).

UPPER LABEL (Forward-Facing)

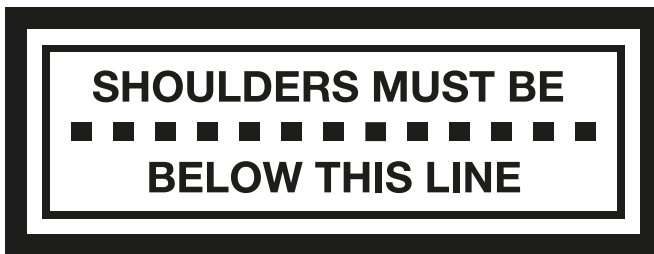

Children are at risk of serious injury if they move to booster seats too early.

Children that have outgrown the forward-facing child restraint are safest in a booster seat until their shoulders reach the upper shoulder height marker of the booster seat.

The child restraint is unsuitable for the occupant when the shoulders are above the upper marker. The child needs to be moved into the next form of child restraint eg. Larger Type E booster seat or Type F booster seat when they reach the top shoulder height marker.

For the next child restraint refer to the Restraint Guide on page 5 & 24.

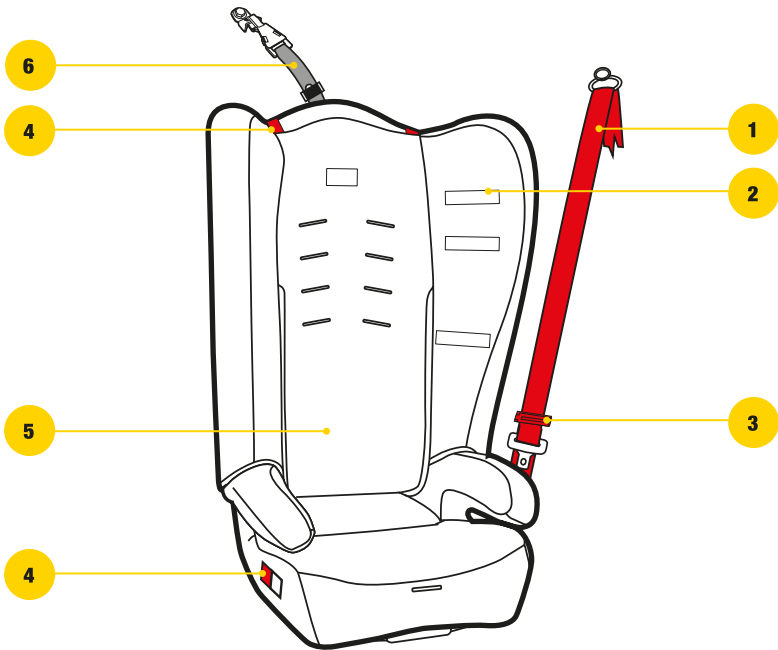

1. Vehicle Seatbelt
2. Shoulder Height Markers
3. **SAFE GRIP** Red Belt Clamp (if applicable)
4. **BOOSTER SEAT BELT PATH®** Marker (each side of restraint - coloured red)
5. Comfort Cover
 - Backrest • Seat Base
6. Top Tether Assembly
 - Tether Strap
 - Adjuster
 - Attachment Clip
 - Anchor Fitting + Attachment Hardware



IMPORTANT

- For a vehicle without a fixed parcel shelf an extension strap(s) may be needed. If so ring (02) 4728 8090 for nearest supply location. (Refer page 49)
- Seat belt extenders should not be used if the seat belt is not long enough to secure the child restraint.

Next Restraint

Next Type of Restraint

Refer to the 'RESTRAINT GUIDE' for the selection for the most appropriate next restraint (refer Page 5). When the child has outgrown the booster seat, then you can use either of the following;

- **Large Booster Seat** – Larger type E or Type F Booster seat.
- **Vehicle Seat Belt** – check the “Five Step Test” for suitability.

Five Step Test

- Step 1:** Can the child sit with their back against the vehicle seat back? (refer Figure 1).
- Step 2:** Do the child's knees bend in front of the edge of the seat? (refer Figure 2).
- Step 3:** Does the sash (shoulder) belt sit across the middle of the shoulder, not on the neck or out near the arm? (refer Figure 3).
- Step 4:** Is the lap belt sitting low across the hips touching the thighs? (refer Figure 4).
- Step 5:** Can the child stay seated like this for the whole trip? (refer Figure 5).

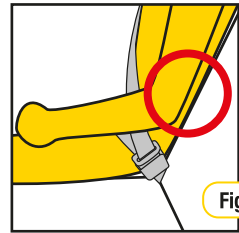

Figure 1

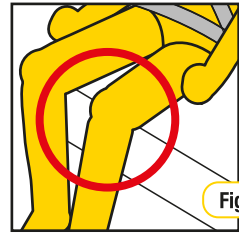

Figure 2



Figure 3

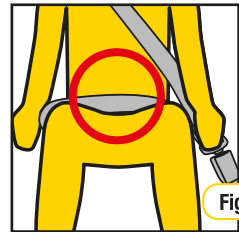

Figure 4

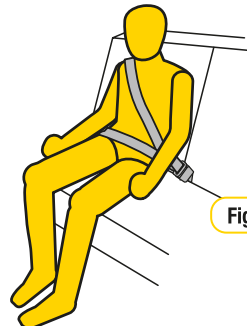

Figure 5

Set Up

Selection of appropriate padding combinations

Step 1: Determine whether your child requires the additional padding provided with this restraint, to ensure a safe and snug fit in the restraint. Refer to page 6 for suggested padding combinations.

Converting to a child booster



IMPORTANT

FOR USE OF THIS RESTRAINT AS A BOOSTER SEAT THE HARNESS MUST BE STORED BEHIND THE COVER. FOLLOWING STEPS EXPLAIN HOW THIS IS TO BE DONE.

Step 1: Disengage the buckle, undo the cover flap located between the leg straps, remove buckle pad and place the buckle in the recessed section of the plastic base. Close the flap in the cover (refer to Figure 1 & 2).

Step 2: Disengage shoulder straps from “G” connecting plate as shown on page 12 (refer to section “Shoulder Slot Height” - Step 1 & 2). Remove and store Shoulder Pads & Buckle Pad. Lift the front flap of the seat cover (see Figure 3).

Step 3: UNDER FLAP

Thread the harness strap back through the top shoulder slots and reconnect the “G” plate as per page 12 (refer to section “Shoulder Slot Height” - Step 3 & 4). Tightening the harness with harness adjuster strap located at the front of the seat. Place the two buckle tongues in the recess in the plastic base at point (A) in Figure 3. Resecure front flap of seat cover.

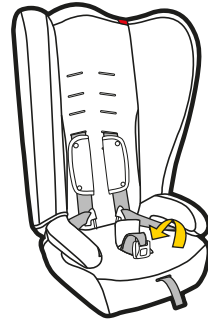

Figure 1

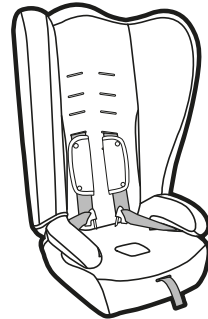

Figure 2

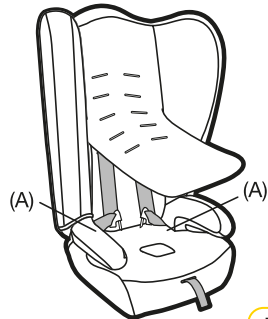

Figure 3

Installation

Converting to a child booster

Attaching Sash Guide (if supplied)

*Can be purchased separately visit <http://store.infasecure.com.au/>

Step 4: The sash guide (if supplied) is stored at the back of the restraint (refer Figure 4).

Step 5: Remove the sash guide by threading the sash guide through the webbing loop (refer Figure 5). Pull the sash guide and strap through to the front of the restraint.

Step 6: Thread the sash guide through the webbing loop (refer Figure 6).

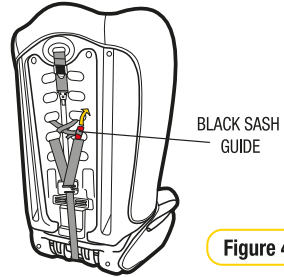

Figure 4

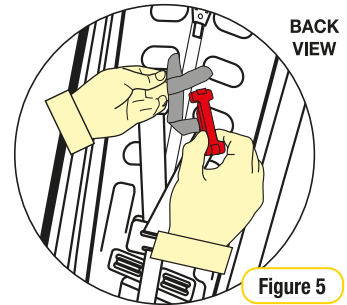

Figure 5

IMPORTANT

You may need your child to sit in the Booster to determine the most appropriate shoulder slots to use to attached the sash guide through.

Step 7: Adjusting the strap length to position the sash guide near your child's shoulder to ensure the cars seat belt sash is in the correct position (refer Figure 7) (See using Lap-Sash seat belt pages 29-31).

The restraint is now ready as a booster seat.

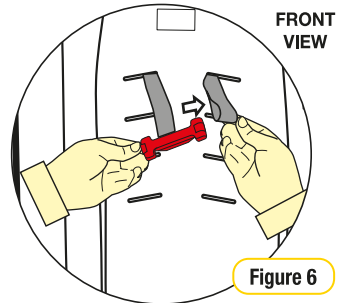

Figure 6

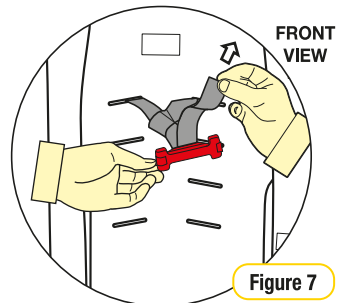

Figure 7

Installation

Adjusting Recline Angle (CS7213 Models Only)

Determine which angle is preferred for the comfort of your child.

TO RECLINE

Pull down the recline base and ensure the support is forward (in position).

***Model CS7113 has no recline feature.**

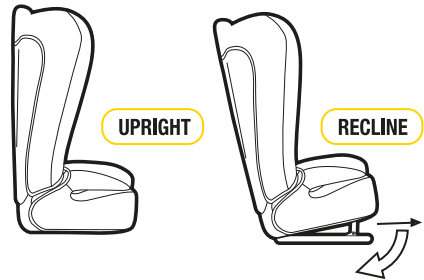

Installing in Vehicle

Step 1: Place the child restraint in the car, in a forward facing seating position (refer the Figure 1).

Step 2: If required install the upper anchorage fitting as shown on page 40 & 41 of these instructions.

Step 3: Hook the attachment clip to the anchor fitting. Ensure there are no twists in the upper anchorage strap (Refer to Figure 2).

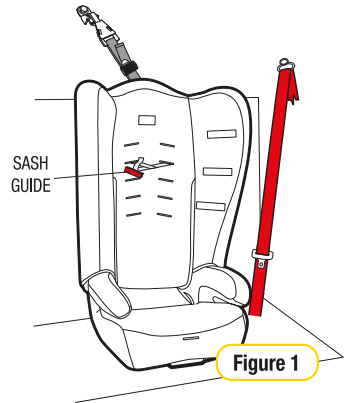

Figure 1

WARNING

- DO NOT USE WITH JUST A LAP BELT. You must use a lap-sash seat belt.

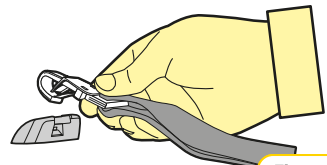

Figure 2

Installation

Installing in Vehicle

Step 4: Pull to tighten and remove all the slack, from the top tether strap (refer to Figure 3). Do not overtighten as this could cause the restraint to lift off the vehicle seat.

Step 5: Roll up and store the excess webbing from top tether strap and store in the pocket provided (refer Figure 4).

CAUTION: CHILDREN CAN BE INJURED OR RESTRAINTS AND TOP TETHER STRAP DAMAGED BY UNSECURED CARGO IN A COLLISION. SECURE OR REMOVE HAZARDOUS CARGO BEFORE USING THIS CHILD RESTRAINT.



IMPORTANT

- Tighten till slack is removed.
- In certain vehicles an extension strap may be needed.
- Do not overtighten Top Tether strap.
- Ensure Top Tether strap is passed through the Top Tether Strap Guide.
- Always secure the loose end of the top tether strap to prevent it hanging out of the car or being accessible by the child.

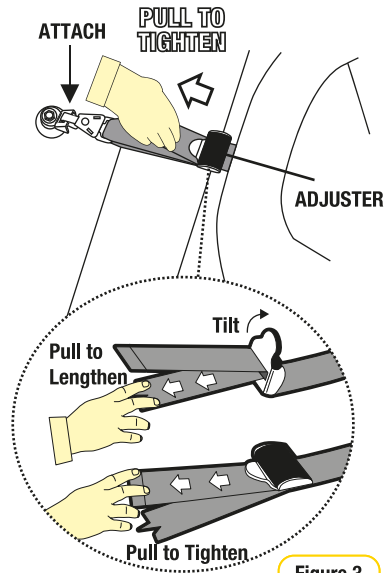

Figure 3

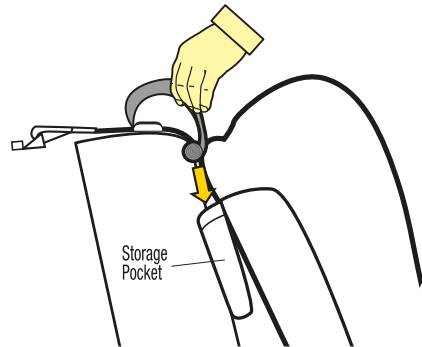

Figure 4

Tether Storage

After correctly installing the restraint in your car, roll up and place any excess tether strap in the storage pocket provided (refer Figure 4).

Use

Using lap-sash seat belt

Step 1: Ensure the restraint has been installed as per “INSTALLING IN VEHICLE” (refer Figure 1)

Step 2: Sit your child in the restraint with their back against the backrest (refer Figure 2).



IMPORTANT

Ensure that you use the **BOOSTER BELT PATH** identified by the following label.



Step 3: Position the lap section of the vehicle seat across the child's lap then insert the buckle tongue in to the belt buckle until you hear “CLICK”. Ensuring the lap portion is positioned under the armrests and over the child's thighs (refer Figure 3).

The red “Booster Seat belt Path” labels are located each side of the Booster seat and on the head rest.

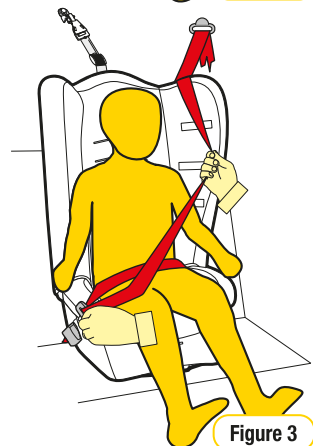

WARNING

- DO NOT USE WITH JUST A LAP BELT. You must use a lap-sash seat belt.

Use

Using lap-sash seat belt

Step 6: Pull the lap belt tight by first pulling on the lap belt in the direction of arrow 1 (refer Figure 4). Pull the sash belt tight in the direction of arrow 2.



WARNING

- ALWAYS USE THE SASH GUIDE

Safe Grip (if supplied)

*Can be purchased separately visit <http://store.infasecure.com.au/>

SAFE GRIP BELT CLAMP

It is important that the lap belt must be **firmly across the thighs**. The **Safe Grip locks the lap belt** to ensure a firm fit across the thighs, and avoids slack in the lap belt. This fit ensures that the lap belt **does not ride up** into the soft abdominal region of the child, which may cause internal injury.

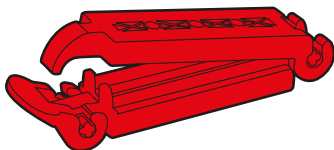

To install the **Safe Grip** (red belt clamp);

Continue from **Step 6:** while holding the belts tight open the Safe Grip and clamp the “sash section” of the vehicle seat belt by closing the barrel section of the red belt clamp in the direction of arrow 3 (refer Figure 5) and then locking with the toggle section by pushing in the direction of arrow 4 (refer Figure 5) Note: Positioned as close as possible to the buckle and tongue. When the **Safe Grip** (red belt clamp) is secured in place, the lap section is now tightly holding your child in place, independent of the sash section.

The **Safe Grip** (red belt clamp) can be left located on the sash belt when the child is removed from the booster. It is then ready for the next use. Repositioning of the **Safe Grip** (red belt clamp) may be required as the child grows. The **Safe Grip** (red belt clamp) must be removed when the child restraint is not installed to allow other users to use the seat belt as a lap/sash seat belt. Always keep the **Safe Grip** (red belt clamp) in pocket provided when not in use.



Figure 4

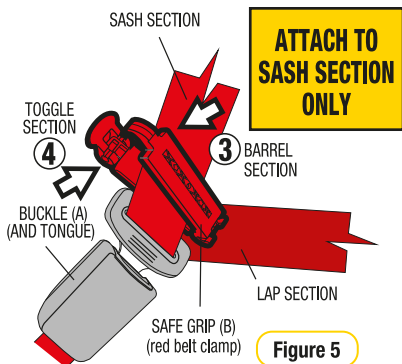

Figure 5

Use

Using lap-sash seat belt

Sash Guide (if supplied)

*Can be purchased separately visit <http://store.infasecure.com.au/>

Step 7: Pass the shoulder belt through the belt sash guide (refer Figure 6) which is fastened to the restraint by a webbing strap. Adjust the position so that the shoulder belt lies comfortably over the child's shoulder (Refer Figure 7). Adjust to the required length.



WARNING

- DO NOT LEAVE CHILDREN UNATTENDED IN THE CAR
- Fit the seat belt firmly to the child.
- ALWAYS USE THE SASH GUIDE

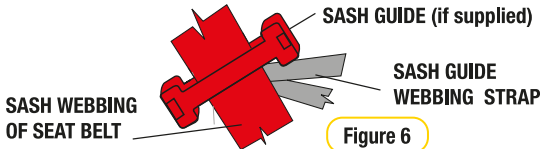

Safety Warning



WARNING

A SASH BELT UNDER THE ARM OR BEHIND THE BACK IS DANGEROUS

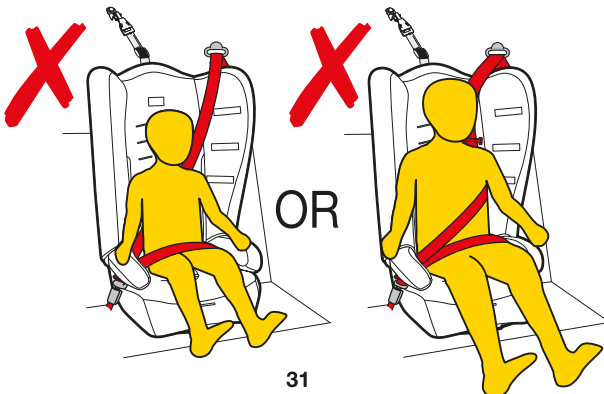

Use

To release child

Step 1: To release your child from the booster seat simply press the belt buckle and carefully remove your child from the seat.

It is not necessary to release the red belt clamp, to remove your child (if applicable).

Note: When the restraint is not in use, the seat belt should be fastened around it and engaged.



WARNING

- Always use lap-sash seat belt and upper anchorage strap to attach the child restraint to the vehicle.
- Do not use the restraint without the upper anchorage strap correctly attached and adjusted.
- Do not use on any vehicle seat which faces sideways or rearwards.
- IF AN AIRBAG IS FITTED IN THE SEATING POSITION WHERE THE CHILD RESTRAINT IS TO BE FITTED, FOLLOW THE VEHICLE MANUFACTURER'S WARNINGS AND INSTRUCTIONS.
- DO NOT USE WITH JUST A LAP BELT. You must use with a lap-sash seat belt
- Ensure the lap belt is correctly positioned on the child's thighs and hips.
- Do not place the seat belt sash under the arm or behind the back of the child.

Care of Restraint

The child restraint cover has been manufactured to meet the Australian Standards requirements for flammability and toxicity to ensure your child's safety. The cover has also been designed to provide your child with comfort and support.

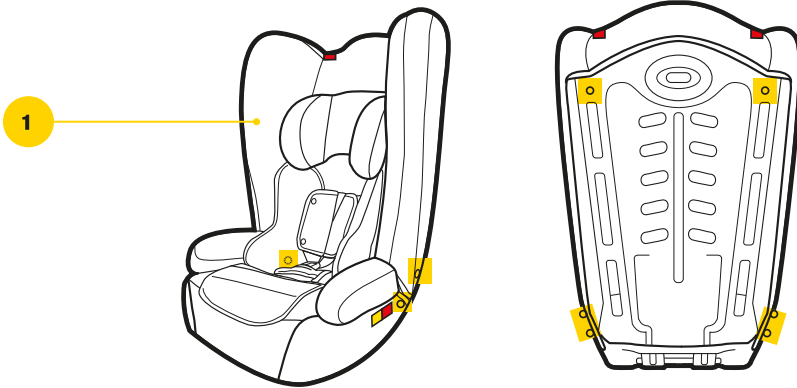

1. Main Cover

VERY IMPORTANT

Only replace the cover with a InfaSecure supplied replacement cover with identical shoulder height markers or a replacement cover meeting AS/NZS 8005.

Care and Maintenance

Regular care of the restraint will ensure safety of your child.

- Check the webbing for fraying.
- Check the upper anchorage attachment clip to ensure retainer clip is still present.
- Ensure there are no cracks in moulding or the plastic moulding.
- Check the buckles “click” when you engage tongues and is not sluggish or sticky in operation.
- Ensure the buckle is free of fluff, liquid, or other matter that may enter the buckle slots. Clean the buckle if it is sluggish to engage (refer Cleaning Buckle Page 42)
- Check the harness adjuster is operating and is clamping the webbing
- If any part of the restraint is cracked or broken, seek repair immediately or replace the child restraint.

Cleaning



IMPORTANT

Use only mild soap and water to clean all parts of the CS7113 / CS7213 Convertible Car Seat.
Do not use chemicals or cleaning agents
Cold water only to be used and to be rinsed well
Do not dry clean or tumble dry
Do not bleach.

Covers

The restraint has a flame retardant cover which is removable for cleaning. Cleaning instructions are on the care label attached to the cover. If a fluffy cover is fitted, then washing the cover prior to use will remove excess fluff.

The cover has been designed to protect your child when seated in the restraint. Care should be taken, if children either eat or drink while in the restraint, as some food or drink products may cause damage or marking to the cover. Wash or clean immediately. Do not pull sticky items from covers as the cover may be damaged - soak in water and gently remove.

Only machine wash on gentle cycle (hand washing is recommended). When washing the covers, ensure the hook and loop attachment strips are connected to eliminate other materials or garments being caught. Ensure that the hook and loop attachment strips are free of lint, this will ensure a positive engagement.



IMPORTANT

For **Velour** or **Leatherette** fabric only sponge clean with a damp cloth.

Seat + Hardware

Use only mild soap and water to clean all webbing, metal and plastic parts of the restraint using a damp cloth.
Do not use chemicals or cleaning agents.

Harness Straps

Use only mild soap and water to clean all straps, using a damp cloth the harness straps can be soaked, however they must be thoroughly dried without excessive heat (never tumble dry). The harness straps should not be placed in a washing machine as this may cause damage to the stitching or even damage your washing machine.
Do not use chemicals or cleaning agents.

Cleaning

Harness Buckle

If sticky liquids such as baby formula, fruit juice, etc. get inside your Harness Buckle, it may become sluggish. An indication of a sluggish Harness Buckle is that you cannot hear a “CLICK” when engaging the Harness Tongues. To restore the Harness Buckle to good working order it needs to be cleaned as follows:

Step 1: From the underside of the restraint pull each crotch 3-bar slide then turn 3-bar slide and push through each slot to remove the Harness Buckle from the restraint (refer Figure 1).

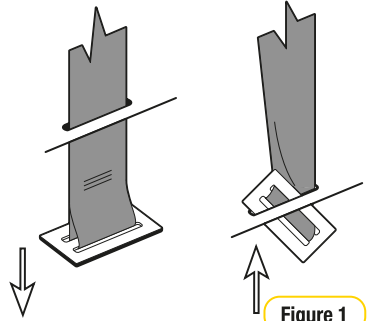

Figure 1

Step 2: Place the Harness Buckle under warm (max. 40 degrees Celsius) running water as shown below. Let the water run through the mouth of the buckle for five minutes (refer Figure 2).

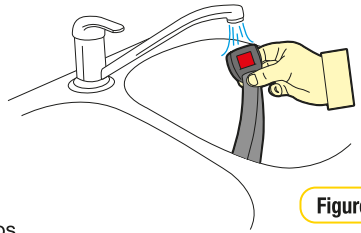

Figure 2

Step 3: Engage and disengage the Harness Tongues and Buckles several times until a strong audible “CLICK” is heard when inserting the last tongue (refer Figure 3).

Step 4: If you still cannot hear a strong audible click after engaging the Harness Tongues and Buckle, then repeat cleaning several times. If the Harness Buckle cannot be returned to its original working condition then contact InfaSecure Customer Service 02 4720 8090.

Step 5: Refit the harness buckle to the restraint with the red button facing out and feeding each 3-bar slide through appropriate slot. Always ensure the webbing crotch straps are thoroughly dried before installing.



Harness Buckle Care

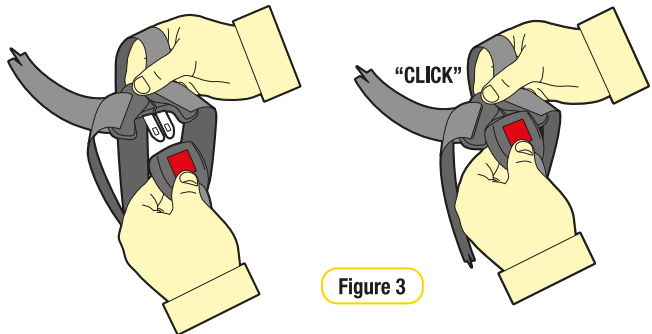

Figure 3

Remove & Replace Covers

Main Cover

To Remove Harness

- Step 1:** Disengage shoulder straps from “G” connecting plates as shown on page 12 (refer to section “Shoulder Slot Height” - Step 1 & 2).
- Step 2:** Disengage buckle tongues from the buckle.
- Step 3:** Pass the three bar slide located below the thigh harness slots on the end of each body/shoulder straps through the thigh harness slots. Each side of harness is now removed. (see Figure 2).
- Step 4:** To release the buckle / crotch strap pass the three bar slides attached through the crotch slot holes in seat section (see Figure 3).

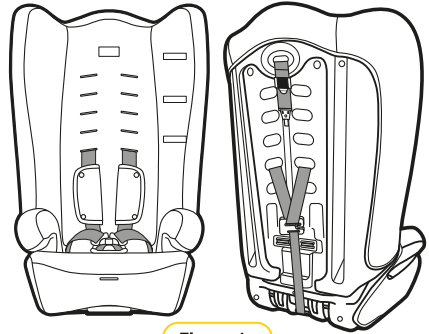

Figure 1

To Replace Harness

- Step 1:** Connect the buckle/crotch strap by feeding the three bar slides on the crotch strap through the holes in seat section (see Figure 3).
- Step 2:** Reconnect shoulder straps to “G” connecting plate as shown on page 12 (refer to section “Shoulder Slot Height” - Step 3 & 4).
- Step 3:** Engage the buckle tongues in the buckle.
- Step 4:** Feed the lap end of the harness and the three bar slide through the thigh slots (see Figure 1 & 2).

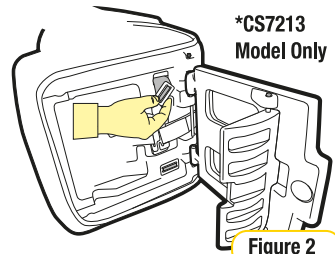

Figure 2

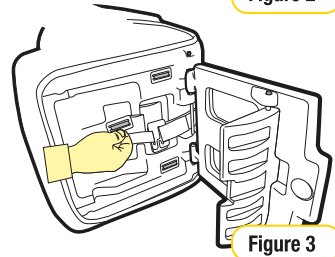

Figure 3

To remove and replace covers

BASE COVER:

- Step 1:** Disengage buckle and tongues.
- Step 2:** Push the buckle through the crotch slot in the cover.
- Step 3:** Unclip the four press studs and remove Base Cover.

BACKREST COVER:

- Step 1:** Do Step 1 from “To Remove Harness”.
- Step 2:** Unclip the four press studs at the bottom of the cover and disconnect the two elastic loops located at the top of cover (rear).
- Step 3:** Remove Backrest Cover.

TO REPLACE COVERS REVERSE THE ABOVE PROCEDURE.

Extension Straps

If required contact InfaSecure for nearest supply location. Extension straps, not included in this package, may be required for vehicles without a fixed parcel shelf.

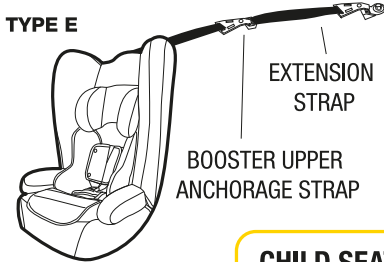

Re order Line Numbers	
CS111	300mm Length
CS112	600mm Length
CS113	200mm - 900mm Adjustable Length

If required contact Infa Secure Customer Service 02 4728 8090 for nearest supply location.

Accessories

Follow the instructions covering the use of accessories provided with this child restraint or spare parts provided by InfaSecure for this restraint.

IMPORTANT

Use of unauthorised aftermarket accessories (i.e items not provided in this box with the child restraint), can reduce the safety provided by the child restraint and may cause injury or death.

BUCKLE PAD (if fitted)

The buckle pad is designed to add extra comfort for baby or child.

Step 1: Position the buckle pad behind the buckle and clip in the front. The release button should be clearly visible.

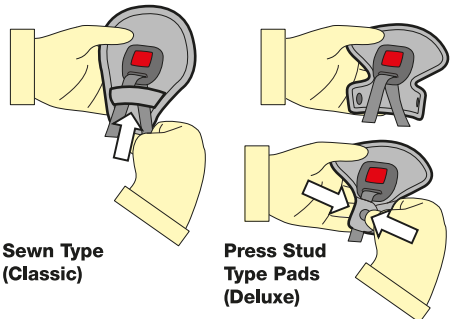

Accessories

SHOULDER PADS (if fitted)

The shoulder pad is designed to add extra comfort for baby or child.

Classic

- Step 1:** Turn the restraint so that the back of the seat is facing you.
- Step 2:** Remove each shoulder harness through the “G” connecting plate (refer Figure 1 & 2).
- Step 3:** Pull the shoulder harness straps through the shoulder slot holes in the seat body and cover. They are now loose in the front of the seat (refer Figure 2).
- Step 4:** To attach shoulder pads, slide the shoulder pad over the harness straps (refer Figure 3).
- Step 5:** Rethread harness straps as per Steps 1 to 3 above.

The child restraint with shoulder pads is ready to use.

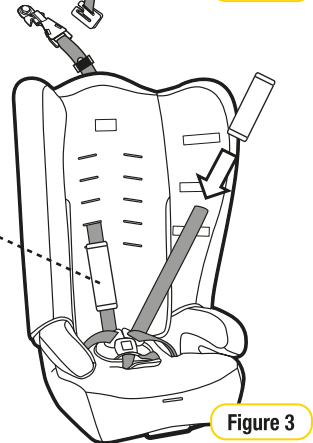
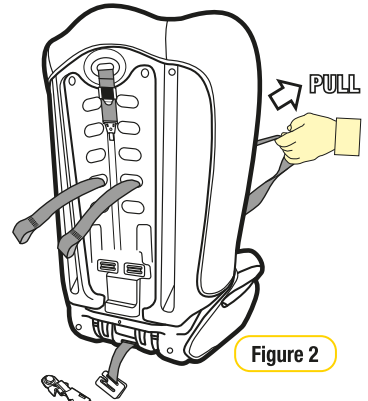
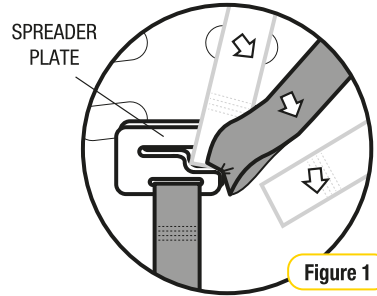
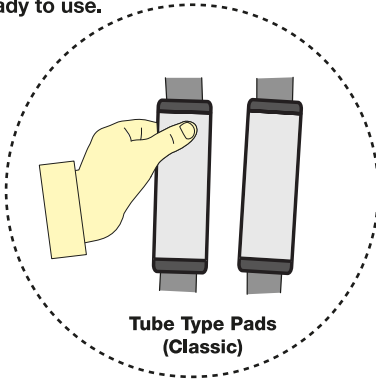

Deluxe

- Step 1:** Separate press-studs and remove the shoulder pads from harness
- Step 2:** To attach shoulder pads, ensure press studs face away from the child and re-attach.

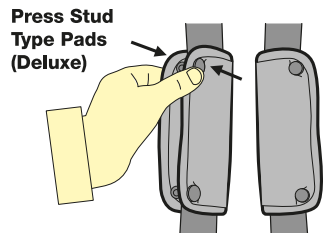

Accessories

HEAD PILLOW/INFANT PILLOW (if fitted)

The head pillow/infant pillow (if fitted) is designed to provide extra comfort.

- Step 1:** Position the bottom of the pillow's side wings at the top of the child's shoulders.
- Step 2:** Feed the upper and lower pillow straps through the nearest slots.
- Step 3:** Thread the strap through the plastic buckle (or tie a knot) and adjust for a firm fit, which ever is applicable.

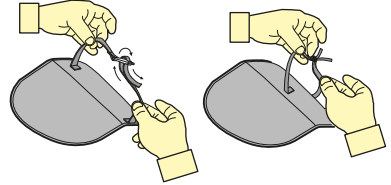
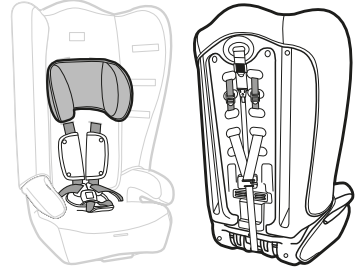

PADDED INSERTS (if fitted)

The padded inserts are designed to add extra comfort for your child.

- Step 1:** Press to release Buckle tongues.
- Step 2:** Open the "press studs" and position the padded insert in the seat.
- Step 3:** Pass the harness straps over the insert and connect the "press studs".
- Step 4:** Pull the Buckle and leg straps through the slot or opening in the insert.
- Step 5:** Connect both tongues into the buckle.

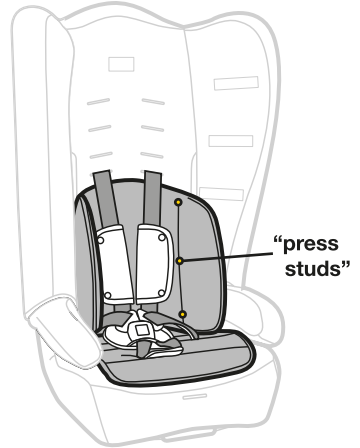

Accessories

SEAT PROTECTOR (if fitted)

The seat protector is designed to protect your car's seat.

STANDARD

Step 1: Position the front flap with pockets, at the front of the rear seat and position the mat rearwards to obtain a flat fit.

FULL LENGTH

Step 1: Position the front flap with pockets, at the front of the rear seat and position the mat rearwards to obtain a flat fit. (If required an additional flap has been provided to tuck in between the seat back & cushion)

Step 2: Position the back section up the seat back and use the plastic buckle & webbing strap to attach around the vehicle seat headrest (if the rear vehicle seat does not have a headrest then the strap could be used to attach around the child seats top tether after you have installed the child seat).

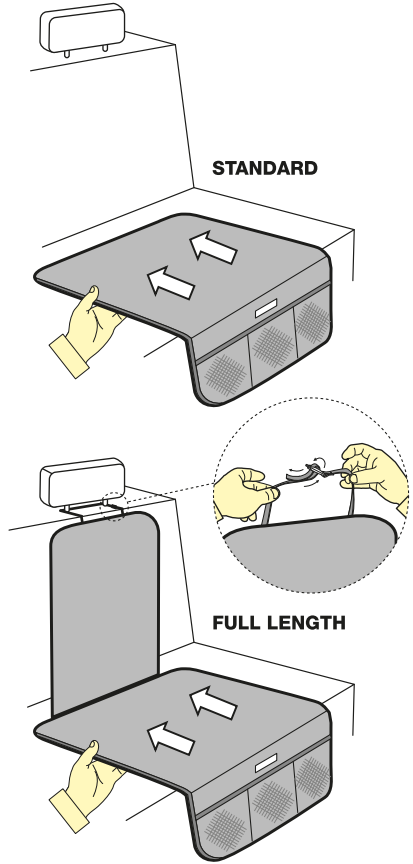

Anchorage Fittings

Some vehicles may have an anchor fitting already fitted by the vehicle manufacturer.

If no anchorage points can be found refer to the vehicle manufacturer, or an authorised child restraint fitting station for the best location of an anchorage point.

Refer to the vehicle owners handbook or child restraint fitting station for the possible use of spacers.

Some vehicles may require the use of additional extension straps (not supplied with this child restraint)

If so ring InfaSecure on (Aust) (02) 4728 8090 for nearest supply location.

ADDITIONAL EXTENSION STRAPS AVAILABLE:

CS111 300mm Extension strap

CS112 600mm Extension strap

CS113 200 - 900mm Adjustable Extension strap



WARNINGS

- Top tether strap and attachment clip must always be used
- Always ensure that the upper attachment clip is correctly engaged to the anchor fitting
- THIS RESTRAINT MUST BE ATTACHED TO A CHILD RESTRAINT ANCHORAGE POINT IN THE CAR. REFER TO CAR OWNER'S HANDBOOK FOR LOCATION OF ANCHORAGE POINTS. REFER TO A CHILD RESTRAINT FITTING STATION IF NO CAR ANCHORAGE POINTS ARE IN THE MOTOR CAR.
- THIS RESTRAINT IS NOT SUITABLE FOR USE WHERE TOP TETHER STRAP MAY FALL INTO A SPLIT IN THE SEAT BACK OR OFF THE SIDE OF THE SEAT.

For cars fitted with a child restraint anchorage point

THIS RESTRAINT MUST BE ATTACHED TO A CHILD RESTRAINT ANCHORAGE POINT IN THE CAR.

LOCATE THE ANCHORAGE POINT BEHIND THE REAR SEATING POSITION

CONSULT THE CAR OWNER'S HANDBOOK FOR LOCATION OF ANCHORAGE POINTS.

REMOVE THE THREAD PLUG FROM THE PARCEL SHELF/FLOOR/ROOF AND INSTALL THE ATTACHMENT BOLT AS SHOWN IN FIGURE 1A & 1B.

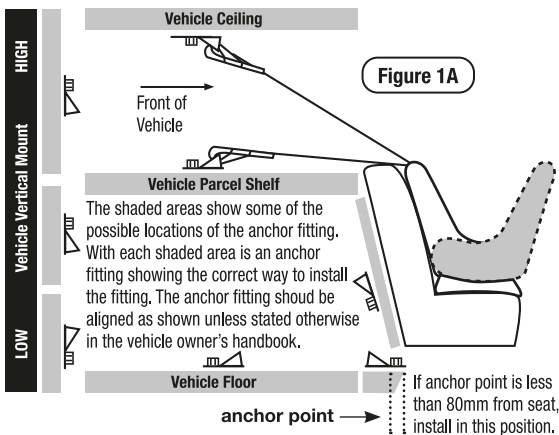

WARNING: If A.D.R. anchorage point is recessed, spacer(s) may be required. Spacer Part No's are as follows:
10mm - CCS001;
5mm - CCS002

UPPER ANCHORAGE FITTINGS

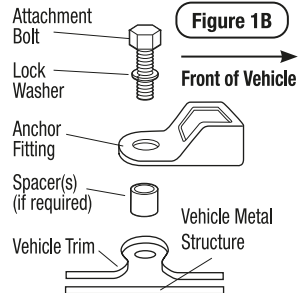

CAUTION: DO NOT OVERTIGHTEN ATTACHMENT BOLT. MAXIMUM TORQUE IS 20NM.

Anchorage Fittings

For cars not fitted with a child restraint anchorage point

For Sedans Only

Drill a 9mm diameter hole in the parcel shelf on the centre line of the seating position as shown in Figure 1C. Hole must be no closer than 200mm from the front of the back seat. Install the anchor bolt as shown in Figure 1D.

Note to Queensland purchases: The installation of anchorage points must be approved by authorised officers appointed by Queensland Transport. Authorised officers can be sourced from all Queensland Transport Customer Service and Queensland Ambulance Service Centres.

For Vehicles other than Sedans

In Australia, consult your nearest child restraint fitting station of traffic authority for vehicle inspection to find the best, correct position for the placement of the anchorage point, and for the correct attachment bolt length use of spacers.

In New Zealand consult the agent of the vehicle.

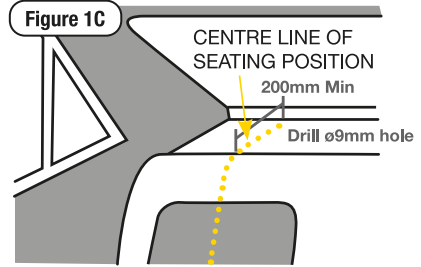

UPPER ANCHORAGE FITTINGS FOR SEDANS ONLY

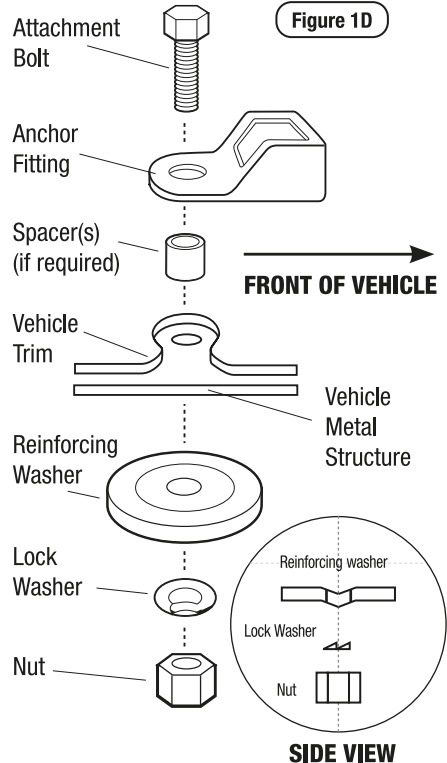

WARNINGS

CHILD RESTRAINTS MUST NOT BE ATTACHED TO UNSOUND METAL OR WOOD OR SYNTHETIC STRUCTURES. WHEN DRILLING THE 9MM HOLE DO NOT DRILL THROUGH FUEL LINES, FUEL TANKS, ELECTRICAL WIRING OR RADIO SPEAKERS. WEBBING STRAPS MUST BE PROTECTED FROM SHARP CORNERS AND EDGES.

THE ANCHOR FITTING MUST BE USED ONLY AS DESCRIBED ABOVE. IT MUST NOT BE HOOKED ONTO ANY OTHER OBJECT.

Insurers Information

If your restraint has been involved in a severe crash, you should destroy the restraint even if no damage is obvious. Some insurance companies offer vehicle insurance which covers or partially covers the replacement of your child restraint. Contact your insurance company for further details.

Your insurance company may require you to keep the child restraint for assessment, but do not use the child restraint after a severe crash. To assist you in making an accident insurance claim cut the following statement and include it with your claim.

NOTICE TO INSURANCE COMPANY CHILD RESTRAINT INVOLVED IN AN ACCIDENT

All InfaSecure child restraints are manufactured to Australian/New Zealand Standards AS/NZS1754 which requires us to advise users of child restraints to "Destroy the entire restraint if it has been in use in a severe crash, even if no damage is obvious".

The Australian/New Zealand Standards committee, advise that this statement applies whether a child was in the child restraint or not. We consider a "severe crash" as being one where the main body structure of the vehicle is distorted.

There is no method of determining if the restraint has been damaged and we concur with the Australian/New Zealand Standards in recommending destruction of the child restraint.

This notice is to advise you of the requirements of the Australian/New Zealand Standards and our obligation in complying with the standards.

Please assist the owner of this restraint in their claim.

INFASECURE PTY LTD ABN: 52 149 173 660

Head Office and Registered Address
110-114 Old Bathurst Rd, Emu Plains, NSW 2750
P.O. Box 487, Emu Plains, NSW 2750

Head Office
P: 02 4728 8000
F: 02 4728 8040
www.infasecure.com.au



Notes:

A series of horizontal dotted lines for writing notes.

Notes:

A series of horizontal dotted lines for writing notes.

LIFETIME WARRANTY

ON SUPER STRONG BLOW MOULDED SHELL PRODUCTS

Register your product to receive **lifetime warranty***, product updates and information.

 Please visit [infsecure.com.au/warranty-registration](https://www.infsecure.com.au/warranty-registration) to register your product.

InfSecure Warranty

InfSecure Pty Ltd warrants this product for twelve months from the date of purchase against failure due to manufacturing faults or faulty materials. Misuse, accidental damages, normal wear and tear are not covered by this warranty.

When used for commercial use the period is limited to six months. "Our goods come with guarantees that cannot be excluded under the Australian Consumer Law. You are entitled to a replacement or refund for a major failure and for compensation for any other reasonably foreseeable loss or damage. You are also entitled to have the goods repaired or replaced if the goods fail to be of acceptable quality and the failure does not amount to a major failure."

Additional Warranty on Blow Moulded Child Restraints

Our blow moulded child restraints are covered against faulty materials and manufacturing when used under normal conditions and according to the instructions.

In the unlikely case that you do have a fault in relation to material quality or manufacturing that restricts your ability to use your Child Restraint normally, we will repair or replace the product within the following warranty periods from date of purchase:

- 12 month warranty for material and fabrics
- 2 year warranty for straps and webbing
- 5 year warranty for hardware and fittings
- Lifetime warranty* on the manufacturing of the seat moulding

Please read your instruction manual carefully before using any of our products. The above express warranties do not apply where a failure or defect results from improper care, misuse or from normal wear and tear.

Refer to website for more details: www.infsecure.com.au

*Lifetime warranty refers to the life span of the seat which is 10 years from the Date of Purchase.



CHILD RESTRAINT SAFETY PARTNER



“ We are proud to be working with The Wiggles. With their help, we are able to reach more young families with much needed information and advice to keep our little ones safe. ”

INFASURE PTY LTD ABN: 52 149 173 660

Head Office and Registered Address
110-114 Old Bathurst Rd, Emu Plains, NSW 2750
P.O. Box 487, Emu Plains, NSW 2750

HEAD OFFICE

Phone No: +61 2 4728 8000
Fax No: +61 2 4728 8040
Email: admin@infa.com.au

CUSTOMER SERVICE

Phone No: +61 2 4728 8090
Fax No: +61 2 4728 8040
Email: service@infa.com.au



Australian Standard

AS/NZS: 1754:2013
Licence No. 25324-1
SAI Global

ISSUE: D