

Convertible Car Seat

INFANT SEAT TO CHILD SEAT
CS8313



REARWARD FACING



FORWARD FACING

(Rearward Facing) Suitable for children from birth to approximately 30 months* of age.
(Forward Facing) Suitable for children from 12 months of age to approximately 4 years* of age.

Instruction Manual

IMPORTANT: KEEP THIS BOOKLET IN THE PLACE PROVIDED ON THE CHILD RESTRAINT

*All references to age are approximates only and reference to children of average proportions. Children vary in shapes and sizes. The photo displayed is indicative of the type of restraint and may vary slightly depending on the model.



Australian Standard

AS/NZS: 1754:2013
Licence No. 25324-1
SAI Global

Contents

Contents	1
Information	2
Warnings	3
Restraint Guide	5
Padding - Combination Guide	6

Infant Seat

Information	7
CS8313 Child Restraints (Itemised list)	8
Shoulder Height Marker	9
Set Up	
- General	11
- Selection of Appropriate Padding Combination	12
- Converting to Infant Seat	12
- Shoulder Height	15
Installation	
- Installing using Vehicle seatbelt	16
Use	
- Using Inbuilt Harness	20
- To Release Child	23

Child Car Seat

Information	24
Shoulder Height Marker	25
Next Restraint	27
CS8313 Child Restraints (Itemised list)	28
Set Up	
- Selection of Appropriate Padding Combination	29
- Converting to Child Car Seat	29
- Shoulder Height	31
Installation	
- Installing using Vehicle seatbelt	32
Use	
- Using Inbuilt Harness	36
- To Release Child	38
Care of Restraint	
- Care and Maintenance	39
- Cleaning	40
Remove & Replace Covers	42
Extension Straps	43
Accessories	44
Anchorage Fittings	47
Insurers Information	49
Lifetime Warranty	50

Information

This instruction manual covers various models under the Model number CS8313. These child restraints are installed in the rear of the vehicle and can be used either rearward-facing or forward-facing. They can be installed in the vehicle using the vehicle seatbelt & the top tether strap. This Convertible Car Seat is designed to be used by children from approximately 0 months of age up to approximately 4 years of age.

Air Cocoon Technology™ - A Protective Embrace

Air Cocoon Technology™ (A.C.T.) enhances protection by dramatically reducing the impact forces during a crash. A.C.T. utilises a layer of air held inside the entirety of the child restraint shell, offering an increased level of protection across the entire surface area of the restraint. Your child is quite literally cradled in a cocoon of air, offering a true 180 degrees of protection to your child's vital organs.

Air Cocoon Technology™ integrated child restraints start their life as an actual pillow of air. This pillow is moulded into a child restraint, retaining the pillow-like construction while adding incredible strength and structural integrity. This manufacturing process is called blow-moulding. Air Cocoon Technology™ (A.C.T.) is an all encompassing protective 'cocoon' around your child.

No child restraint can guarantee absolute protection from injury in every crash. However, to ensure that your child gets all the protection designed into the restraint please read and follow the instructions exactly and use only InfaSecure recommended parts and accessories.

InfaSecure is an Australian owned and operated family business, which can trace its roots back over 60 years, becoming the single largest Australian owned and operated child restraint company in the country. Today, we are still growing, continuing to innovate and provide high quality products at an affordable price.



Warnings



WARNINGS

- Use the restraint exactly as shown in the instructions.
- Supervision of children is needed because they may be able to undo buckles.
- **DO NOT LEAVE CHILDREN UNATTENDED IN THE CAR.**
- Do not alter or modify this restraint.
- Repairs must only be done by the manufacturers or agent.
- Do not allow the restraint to come into contact with polishes, oils, bleach and other chemicals.
- Destroy the restraint if it has been in a severe crash, even if no damage is visible.
- **DO NOT USE THIS RESTRAINT WITHOUT THE COVER.**
- To ensure infant's back is evenly supported, do not put more than one nappy on the baby and make sure the nappy is not thickly folded at the back.
- **DO NOT USE A REAR-FACING CHILD RESTRAINT WHERE AN AIRBAG IS FITTED IN FRONT OF THE SEATING POSITION.**
- Fit the restraint firmly to the car seat.
- Fit the harness firmly to the child.
- A loose restraint or harness is dangerous.
- Do not harness an infant wrapped in a blanket or swaddled. Any blanket or wrap must only be placed over the harness and infant.
- Always secure the loose end of the top tether strap. Do not use the child restraint where this strap may fall into a split in the seat back or off the side of the seat.
- **ALWAYS ATTACH HOOK AND REMOVE SLACK.**

Please read carefully the whole of the instructions for installation and, in the event of doubt about the method of installation, to consult InfaSecure or agent, or a child restraint fitter, or in New Zealand, to consult the agent for the vehicle.

Warnings



WARNINGS

- THIS RESTRAINT IS NOT SUITABLE FOR USE WHERE THE TOP TETHER STRAP MAY FALL INTO A SPLIT IN THE SEAT BACK OR OFF THE SIDE OF THE SEAT.
- THIS RESTRAINT MUST BE ATTACHED TO A CHILD RESTRAINT UPPER ANCHORAGE POINT IN THE CAR. REFER TO CAR OWNER'S HANDBOOK FOR LOCATION OF ANCHORAGE POINTS. REFER TO A CHILD RESTRAINT FITTING STATION IF NO ANCHORAGE POINTS ARE IN THE MOTOR CAR.
- Always secure the loose end of the top tether strap to prevent it hanging out of the car or being accessible by the child. Do not use the child restraint where this strap may fall into a split into the seat back or off the side of the seat.
- IF AN AIRBAG IS FITTED IN THE SEATING POSITION WHERE THE CHILD RESTRAINT IS TO BE FITTED, FOLLOW THE VEHICLE MANUFACTURER'S WARNINGS AND INSTRUCTIONS.
- THIS CHILD RESTRAINT IS NOT APPROVED FOR USE WITH ANY CONNECTORS THAT CONNECT TO THE CARS ISOFIX LOW ANCHORAGES.



WARNING









DO NOT LEAVE CHILDREN UNATTENDED IN THE CAR.

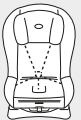

IMPORTANT

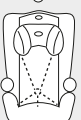
There is a real potential for an infant to be ejected and killed if the baby is wrapped in a blanket or swaddled. The harness need to fit the baby firmly and any blanket or other covering my only be placed over the harness after the harness is adjusted firmly. Please ensure the baby's arms and legs are not bound or wrapped together.

Restraint Guide

MODE	Infant Seat		Child Seat		Booster Seat		Seat Belt		
	BIRTH	2	4	6	7	8	10	12+	
REARWARD-FACING RESTRAINT (TYPE A1) BIRTH TO APPROX 6 MONTHS 	REARWARD FACING		0 to 6 (months)						
CONVERTIBLE CAR SEAT (TYPE A2/B) BIRTH TO 4 YEARS 	REARWARD FACING	FORWARD FACING	Approx 0 to 4 years						
CONVERTIBLE CAR SEAT (TYPE A4/B) BIRTH TO 4 YEARS 	REARWARD FACING	FORWARD FACING	Approx 0 to 4 years						
ZERO TO 8 CONVERTIBLE CAR SEAT (TYPE A1/B/E) BIRTH TO 8 YEARS 	REARWARD FACING	FORWARD FACING	BOOSTER SEAT		Approx 0 to 8 years				
FORWARD-FACING RESTRAINT (TYPE B) APPROX 6 MONTHS TO 4 YEARS 	FORWARD FACING		Approx 6 months to 4 years						
FORWARD-FACING RESTRAINT (TYPE G) APPROX 6 MONTHS TO 8 YEARS 	FORWARD FACING				Approx 6 months to 8 years				
CONVERTIBLE BOOSTER SEAT (TYPE B/E) APPROX 6 MONTHS TO 8 YEARS 	FORWARD FACING		BOOSTER SEAT		Approx 6 months to 8 years				
BOOSTER SEAT (TYPE E) FROM APPROX 4 YEARS TO 8 YEARS 	Approx 4 years to 8 years		BOOSTER SEAT		LARGER BOOSTER SEAT				
BOOSTER SEAT (TYPE F) FROM APPROX 4 YEARS TO 10 YEARS 	Approx 4 years to 10 years		BOOSTER SEAT						
SEAT BELT FROM APPROX 7 YEARS AND OVER 						7 +		10 +	

REQUIRED BY LAW

Allowable by law More Appropriate

IMPORTANT: Research has shown that the likelihood of an accessory child safety harness being used incorrectly is very high and the risk of injuries when incorrectly used is much higher compared to a lap-sash seat belt. InfaSecure recommend that an accessory child safety harness should only be used if a lap-only seat belt is all that is available.

Padding / Inserts

Combination Guide

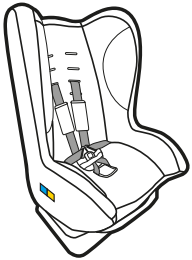
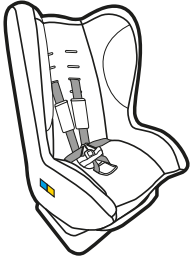
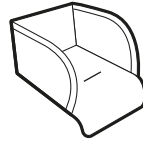
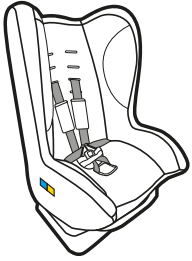

The Padded Insert/s (if fitted) are designed to provide extra support and comfort for small babies. Discontinue use when the insert is a tight fit or creates discomfort for larger babies/children.

MODE

INFANT SEAT
(Small Infant)
REARWARD FACING



INFANT SEAT
(Large Infant)
REARWARD FACING



CHILD SEAT
FORWARD FACING



- Diagrams are indicative of type of paddings and inserts and may not resemble the actual product.
- Padded inserts can vary according to model.
- We reserve the right to alter this product without notice.

*For detailed description and method of attachment for padded accessories refer to Accessories on page 50.

Infant Seat (Rearward Facing)

THE SUITABILITY OF THE CHILD RESTRAINT TO GROUPS OF CHILDREN

TYPE A4

To be used only in a rearward-facing position until the infant's shoulders either reach the lower shoulder height marker (approximately 12 months of age) or reach the middle height marker (approx 2 to 3 years of age).

TYPE B

Then to be used in a forward-facing position until the child's shoulders reach the upper shoulder height marker (approximately 4 years of age).

Continue to use this child restraint until the child reaches this limit.

Do not use forward-facing until child's shoulders are above the lower shoulder height marker.

Infants are at risk of serious injury if they face forward too early.

Children are at risk of serious injury if they move to booster seats too early.

Children who have outgrown this restraint are safest in a larger child restraint with an in-built harness or a booster seat until their shoulders reach the upper shoulder height marker of the restraint.

TO BE USED WITH A LAP-SASH/LAP-ONLY SEAT BELT IN THE BACK OF MOST CARS WITH FORWARD FACING SEATS.

The use of child restraints in the front seat may be restricted for children of specific ages by local legislation. Please check with your local Department of Transport for the specific seating locations of children using child restraints for their given ages.

IMPORTANT

- ONLY USE RESTRAINT REARWARD-FACING and in accordance with these instructions.
- Do not use the restraint without the upper anchorage strap correctly attached.
- DO NOT USE A REAR-FACING CHILD RESTRAINT WHERE AN AIRBAG IS FITTED IN THE FRONT OF THE SEATING POSITION.
- Do not use on any vehicle seat which faces sideways or rearward.
- Do not use the child restraint facing forward.
- Do not use excessively upright or reclined.
- Do not use the aircraft seatbelt path in the car.
- For a vehicle without a fixed parcel shelf an extension strap(s) may be needed. If so ring (02) 4728 8090 for nearest supply location (refer to Page 49).
- Seatbelt extenders are not recommended to be used if the seatbelt is not long enough to secure the child restraint. If seatbelts are too short then advice should be sought from a child restraint fitter and their recommendation be considered before using a seatbelt extender.

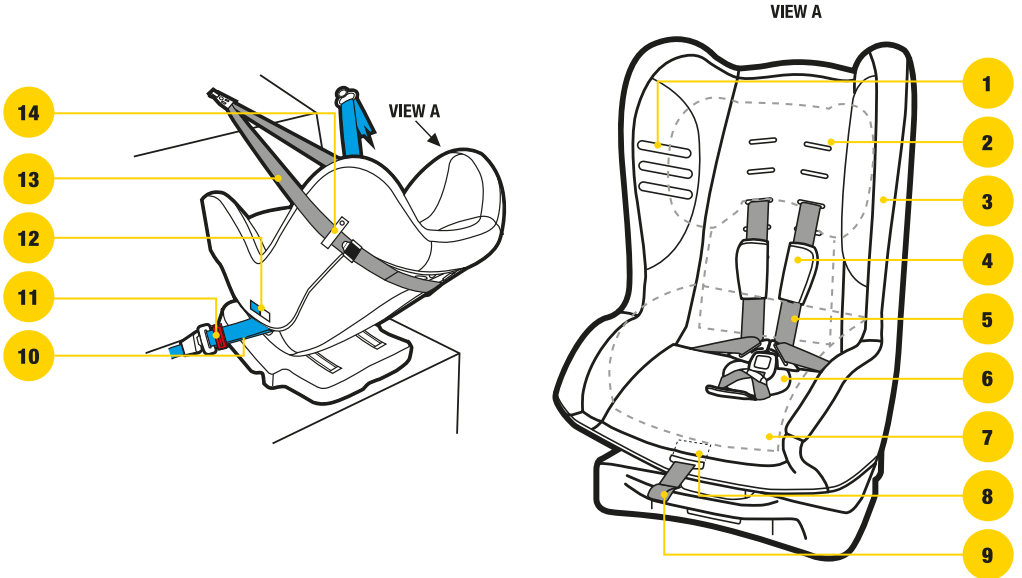

- 1. Shoulder Height Markers
- 2. Pillow (if fitted)
- 3. Comfort Cover
- 4. Shoulder Pads
- 5. Harness Straps
- 6. Buckle Pad
- 7. Padded Insert (if fitted)
- 8. Harness Adjuster
- 9. Harness Adjustment Strap
- 10. Vehicle Seat belt

- 11. Safe Grip Red Belt Clamp (if supplied with restraint)
- 12. "REARWARD-FACING SEAT BELT PATH" Marker (each side of restraint - coloured blue)
- 13. Top Tether Assembly
 - Tether Strap
 - Adjuster
 - Attachment Clip
 - Anchor Fitting + Attachment Hardware
- 14. Top Tether Guide

NOTE: Padded inserts can vary according to model. For detailed description and method of attachment for padded accessories refer to Accessories on page 52.

Shoulder Height Markers

Baby (Rearward Facing mode)

Shoulder height markers are provided on this restraint for a visual indication that the child is safe to travel in this restraint. Do not turn to forward facing until the child's shoulder reaches the lower label.

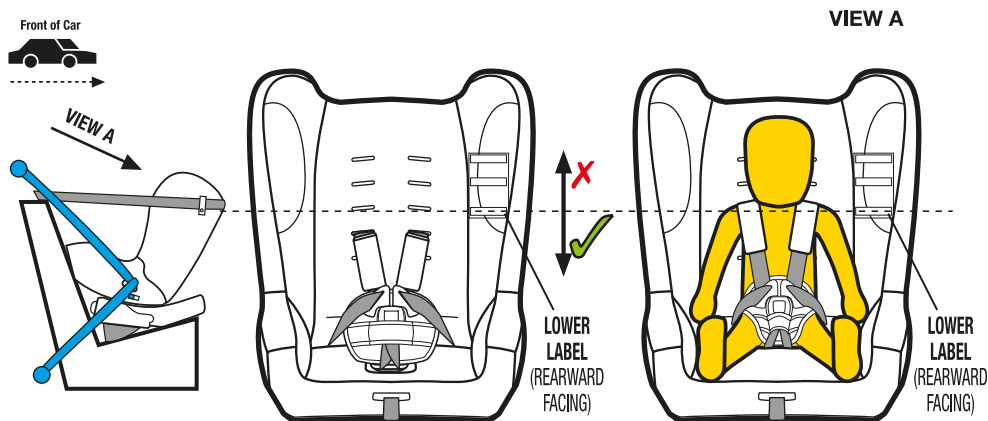

Shoulder height markers may be hidden under a pillow in the lowest position

To be used only in a rearward-facing position for an infant until their shoulders **REACH** the Lower shoulder height marker (approximately 12 months of age).

LOWER LABEL (Rearward-Facing)

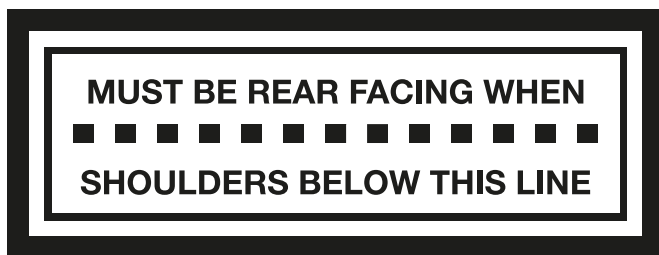

IMPORTANT

Ensure that you continue to use this child restraint in rearward facing positions whilst the infants shoulders are **below** this shoulder height marker (Lower label).

Infants are at risk of serious injury if they face forward too early.

If the infants shoulders are below the lower label or if the baby's neck muscles are unable to support their head, then the infant should remain rear facing. When the child's shoulder reach the lower label, the child restraint may be turned to face towards the front of the car (refer page 29 Child Seat section).

Shoulder Height Markers

Older Baby (Rearward Facing mode)

This restraint must remain rear facing until the child reaches the lower shoulder height marker (approx 12 months old). Once the child's shoulders reach the lower shoulder height marker the restraint can either

- Remain **REARWARD FACING** until the middle shoulder height marker is reached (approx 2 to 3 years) or
- Change to **FORWARD FACING** until the upper shoulder height marker is reached (approx 4 years old).

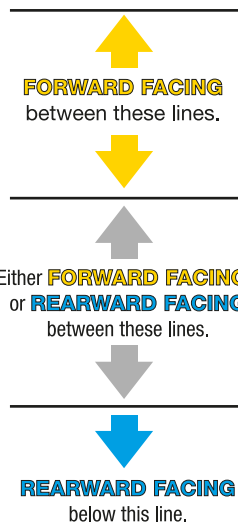
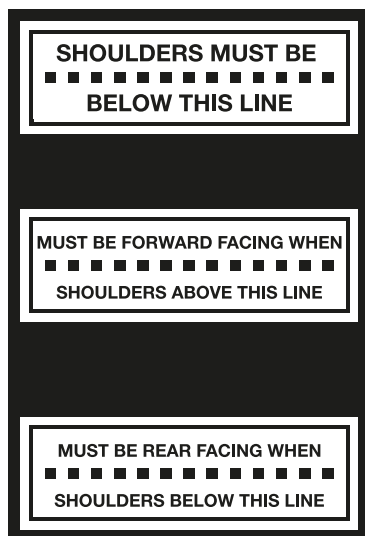
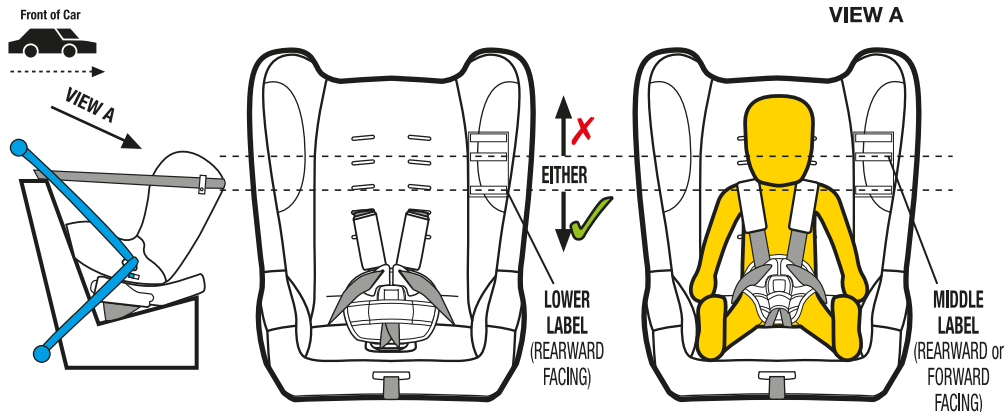

*InfaSecure recommends to use this restraint in **REARWARD FACING** mode as long as possible.*

Set Up

General

- The CS8313 Child restraint has been designed and tested to meet the joint Australian/New Zealand Standard with an inbuilt anti rebound feature and does not require additional anti rebound bars or mechanisms to fulfil these requirements.
- The CS8313 Child restraint has also been designed to be a compact restraint to enable multiple restraints to be used in the rear of most vehicles.

IMPORTANT

- Care and attention should be given to ensure that the baby has adequate ventilation and shading when in the restraint.
- To achieve the necessary distribution of deceleration forces during a vehicle impact, ensure the child is seated correctly in the child restraint and the harness is fitted and adjusted as per these instructions.
- Ensure the child restraint and child are rearward facing.

If the baby's neck muscles are unable to support their head, then the infant should remain rear facing.

The Purchaser should check the measurement between the front of the seat back of the rear seat and all front seats in the car in which the child restraint is intended to be used, to ensure that the space is sufficient.

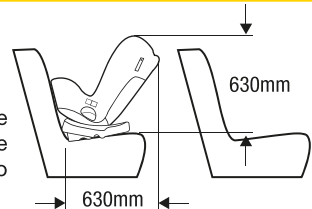

WARNING

- **ONLY USE RESTRAINT IN REARWARD-FACING MODE WITH "RECLINE SECTION" SWUNG FORWARD AND RESTRAINT FULLY RECLINED.**
- Do not use the restraint without the upper anchorage strap correctly attached.
- **DO NOT USE A REAR-FACING CHILD RESTRAINT WHERE AN AIRBAG IS FITTED IN THE FRONT OF THE SEATING POSITION.**
- Do not use on any vehicle seat which faces sideways or rearward.

Set Up

Selection of Appropriate Padding Combinations

Step 1: Determine whether your infant/child requires the additional padding provided with this restraint, to ensure a safe and snug fit in the restraint. Refer to page 6 for suggested padding combinations.

WARNING

- To ensure baby's back is evenly supported, do not put more than one nappy on the baby and make sure the nappy is not thickly folded at the back.

Converting to Infant Seat

Reclined Position

Step 1: At the front of the restraint is a red lever. Pull red lever forward and recline the seat base as far as possible.

Step 2: Ensure the recline section is swung forward (see Figure 1).

Step 3: Ensure the In-built harness "Shoulder straps" are positioned in the appropriate slots.

IMPORTANT

- Refer to the shoulder height labels (As shown on pages 9).
- For correct shoulder strap slot height refer to page 14.

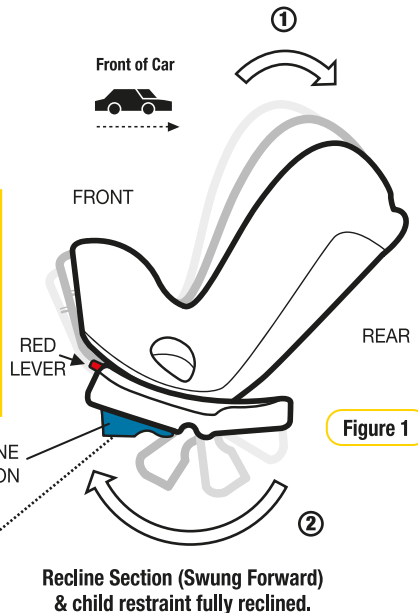
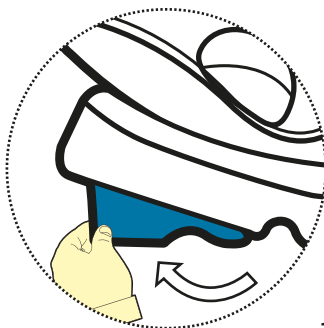

Figure 1

Set Up

Converting to Infant Seat

Adjuster assembly location

The position of the Adjuster (Top Tether strap) is adjustable for ease of installation and ease of use.

Rearward Facing (Type A)

Step 1: Pull adjuster and strap to extend the location of the adjuster assembly (refer Figure 1).

Step 2: Continue to extend until the adjuster has reached the desired location at the side of the restraint (refer Figure 2).

Step 3: Locate the adjuster at the side of the restraint and secure using the Top Tether Strap Guide (refer Figure 3).



IMPORTANT

EASE OF USE: It is recommended to position the adjuster at the side of the restraint which is towards the access door (rear passenger side).

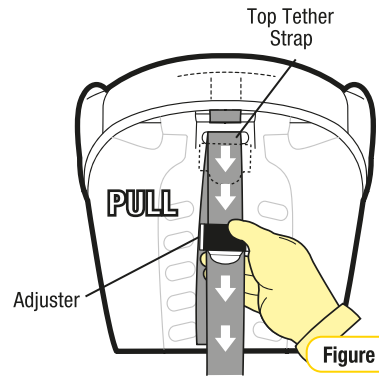

Figure 1

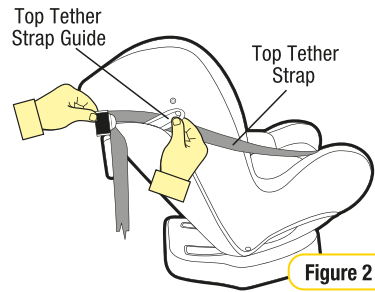

Figure 2

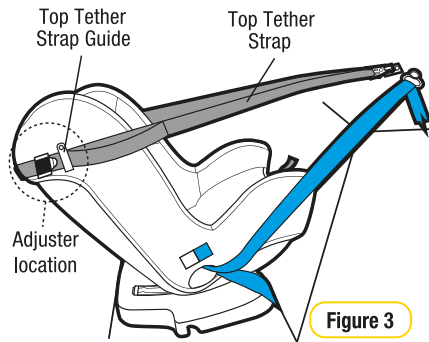

Figure 3

Set Up

Recline Angle

The vehicle installation is controlled by the angle of the vehicle seat, and these angles vary greatly between vehicles. The vehicle seat angle or the contours of the vehicle seat could place the child restraint either too upright or too recline. A rearward facing restraint should always be installed so that the back surface is reclined just enough to allow the infant's head to lie back comfortably, but not more than 45° from vertical. This measurement is taken when your infant is laying in the child restraint and is in direct contact with this back surface, so it's extremely import to maintain the required angle

IMPORTANT

Your infant should NEVER be too upright or too recline.

TOO UPRIGHT (less than 35° from vertical) could lead to the infants head flopping forward and potentially pinching off the airway.

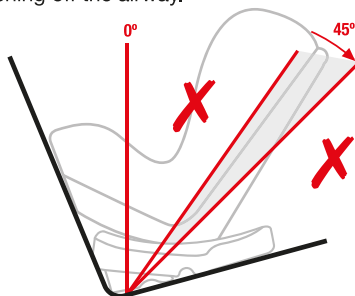

TOO RECLINED (greater than 45° from vertical) could lead to the infants body sliding 'up' towards the top of the restraint. Which could promote a compressive load on the spine and/or an extension load on the neck.

NOTE: An accurate method of measuring the recline angle of your infant is to use a smart phone with a application that can measure angles but if using this method ensure the car is on a level surface.

Shoulder Height

The correct height for the shoulder straps is very important for the optimum performance of the restraint.

IMPORTANT

The shoulder straps must be in the slots which are nearest to the child's shoulders, but not lower than the child's shoulders.

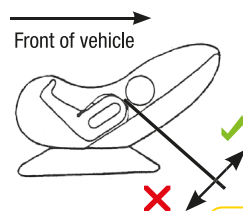

Figure 1

With the child correctly sitting in the restraint, check which set of slots (In the plastic shell of the restraint) are level with or just above the infant's shoulders.

If the harness straps are located in those slots, then the you can proceed with using the restraint (see section "USE" on page 25). If not then adjust the shoulder straps. Refer to "Shoulder slot height" (on page 15).

Setup

Shoulder Height

- Step 1:** Loosen harness to allow spreader plate to rise from under the restraint. Turn the restraint so that the back of the seat is facing you.
- Step 2:** Remove each shoulder harness through the gates in the spreader plate (see Figure 1 & 4).
- Step 3:** Pull the shoulder harness straps through the shoulder slot holes in the seat body and cover. They are now loose in the front of the seat.
- Step 4:** Push the ends of the shoulder harness straps through the appropriate shoulder slot holes in the cover and seat body for the child's shoulder height.

NOTE: Ensure the harness straps are not twisted.

- Step 5:** The shoulder harness straps go directly from the shoulder slot holes to the spreader plate. Thread each shoulder harness strap back onto the metal spreader plate through the gate (see Figure 4).

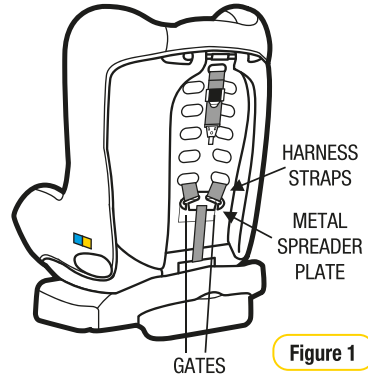

Figure 1

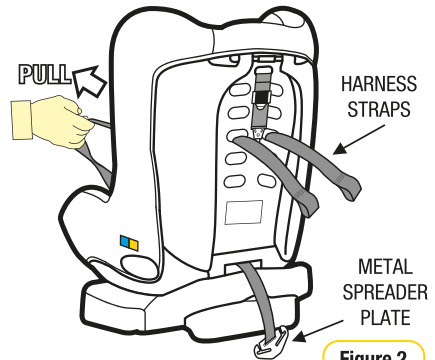

Figure 2



IMPORTANT

The shoulder straps must be in the slots which are nearest to the child's shoulders, but not lower than the child's shoulders.

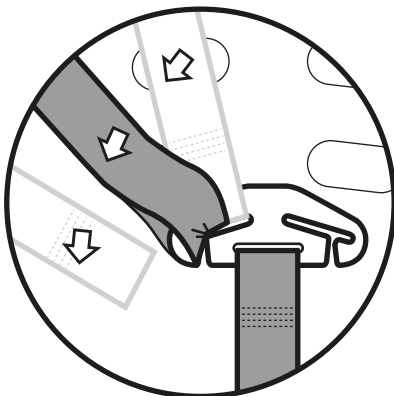

Figure 4

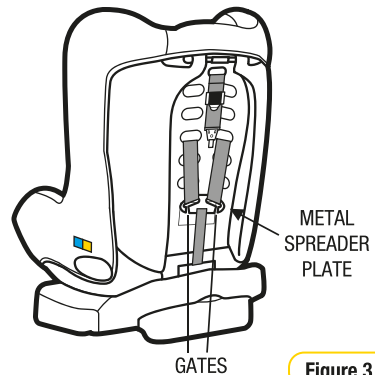

Figure 3

Installation

Installing Using Vehicle Seatbelts

Step 1: Place the child restraint on the vehicle seat. Ensure recline section is swung forward and the restraint is fully reclined with the restraint directly in line with anchorage point.

Step 2: Make sure Top Tether strap is as in illustration (Figures 1 and 2) i.e. positioned around restraint back.



IMPORTANT

Ensure that you use the **REARWARD-FACING BELT PATH** identified by the following label.



Step 3: Feed adult lap or lap/sash belt through the belt path opening, ensure the seat belt is under the cover & between the layer of foam and the plastic seat base.

Engage the buckle and tongue assembly (listen for a **“CLICK”**). Check the buckle engagement with a gentle pull.

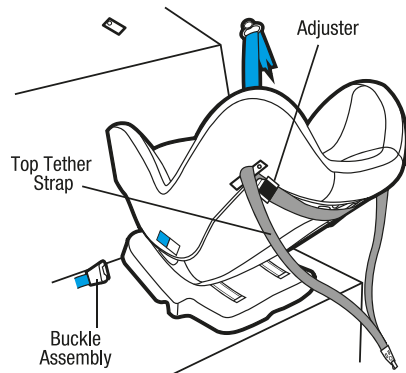

Figure 1

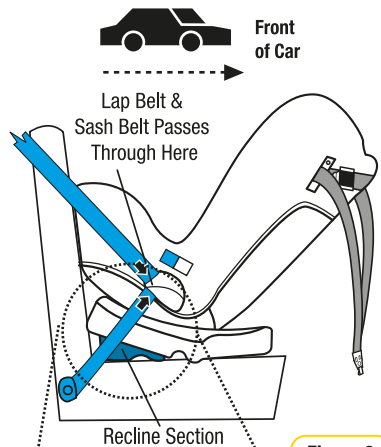
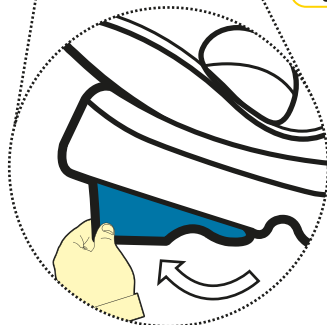

Figure 2



Recline Section (Swung Forward) & child restraint fully reclined.

Installation

Installing Using Vehicle Seatbelts

Step 4: Push down on the base of the restraint (with knee or hand) whilst pulling the sash section of the vehicle belt firmly up in direction of the blue arrow in Figure 4. (This will tighten the lap belt across the seat base).

Step 5: Ensure the excess slack in the sash belt, is fed back towards the seat belt.

Safe Grip (if supplied)

*Can be purchased separately visit <http://store.infasecure.com.au/>

SAFE GRIP BELT CLAMP

The **Safe Grip** (red belt clamp) **locks the lap belt** to ensure a firm installation, and avoids slack in the lap belt.

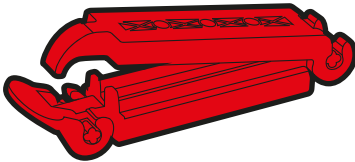

To install the **Safe Grip** (red belt clamp), open it and clamp the “sash section” ONLY of the vehicle seat belt by closing the barrel section of the red belt clamp in the direction of arrow 1 in Figure 5 and then locking with the toggle section by pushing in the direction of arrow 2 in Figure 5 when the **Safe Grip** (red belt clamp) is secured in place, the lap section is now tightly holding your child restraint in place, independent of the sash section. The **Safe Grip** (red belt clamp) must be removed when the child restraint is not installed to allow other users to use the seat belt as a lap/sash seat belt. Always keep the **Safe Grip** (red belt clamp) in pocket provided when not in use.

NOTE: Do not place the **Safe Grip** (red belt clamp) around both the lap and sash sections of the belt. This could cause the **Safe Grip** (red belt clamp) to break.

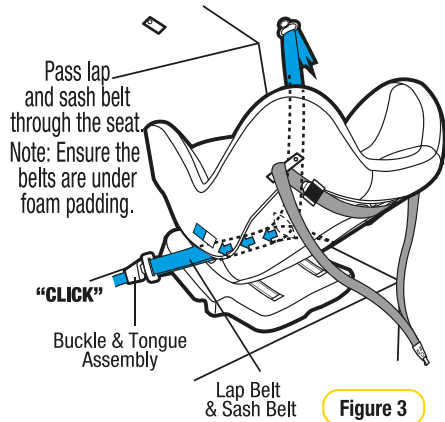

Figure 3

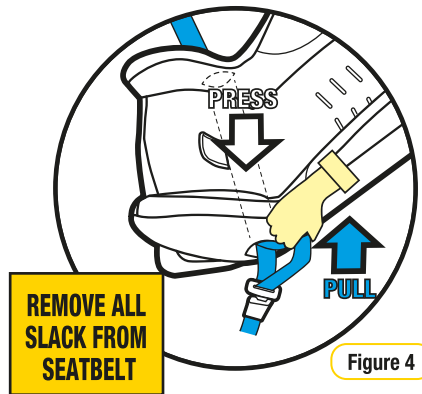

Figure 4

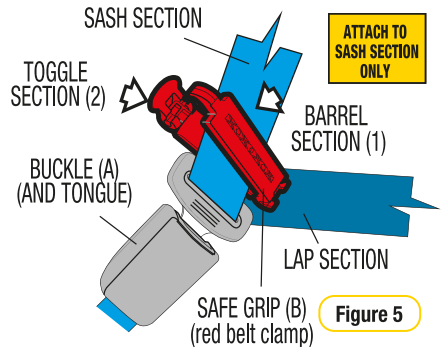

Figure 5

Installation

Installing Using Vehicle Seatbelts

Note: If no upper anchorage fitting is available refer to Pages 47 & 48.

Step 5: Locate the adjuster at the side of the restraint and secure using the Top Tether Strap Guide (refer Figure 6 & 7).

Step 6: Hook the attachment clip to the upper anchor fitting (refer Figure 8). Ensure there are no twists in the top tether strap.

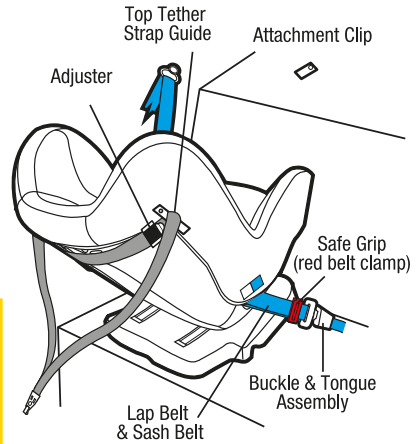

Figure 6

IMPORTANT

- The purchaser should check the measurements between the front of the seat back of the rear seat and all front seats in the car in which the child restraint is intended to be used, to ensure that the space is sufficient.
- Care and attention should be given to sufficient ventilation and shading of the baby. Always secure the loose end of the top tether strap to prevent it hanging out of the car or being accessible by the child.

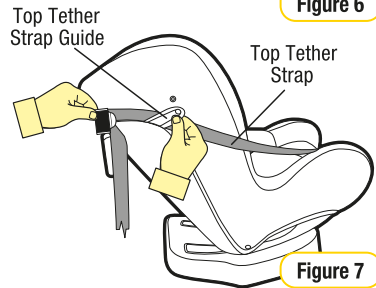

Figure 7

WARNING

- DO NOT USE REAR FACING CHILD RESTRAINT WHERE AN AIRBAG IS FITTED IN FRONT OF THE SEATING POSITION.
- Fit the restraint firmly to the car seat.
- THIS TETHER STRAP MUST ALWAYS BE FITTED WHEN THE CHILD RESTRAINT IS USED IN A VEHICLE.

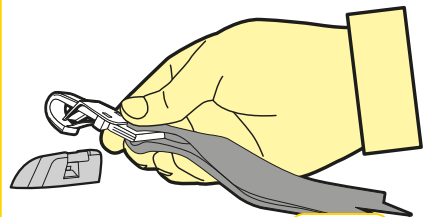

Figure 8

Installation

Installing Using Vehicle Seatbelts

Step 7: Pull to tighten to remove all the slack, from the upper anchorage strap. Do not overtighten as this could cause the restraint to lift off the vehicle seat (refer to Figure 9).

IMPORTANT

- Tighten till slack is removed.
- In certain vehicles an extension strap may be needed.
- Do not overtighten Top Tether strap.
- Ensure Top Tether strap is passed through the Top Tether Strap Guide.

Step 8: Store any excess webbing, from the top tether strap, in the storage pocket provided on the restraint (refer Figure 10).

NOTE

FOLLOWING THE INSTALLATION OF THE CHILD RESTRAINT A SMALL AMOUNT OF MOVEMENT IS DEEMED ACCEPTABLE.

CAUTION: CHILDREN CAN BE INJURED OR RESTRAINTS AND TOP TETHER STRAP DAMAGED BY UNSECURED CARGO IN A COLLISION. SECURE OR REMOVE HAZARDOUS CARGO BEFORE USING THIS CHILD RESTRAINT.

Always secure the loose end of the top tether strap to prevent it hanging out of the car or being accessible by the child.

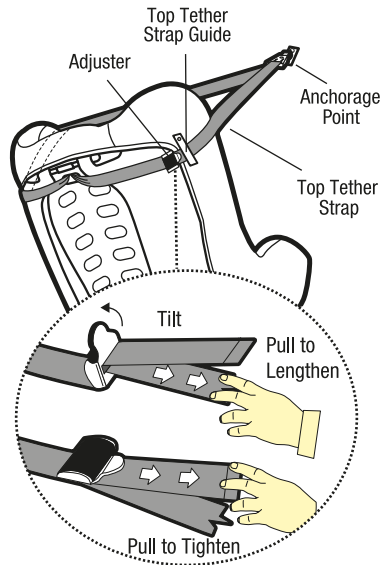

Figure 9

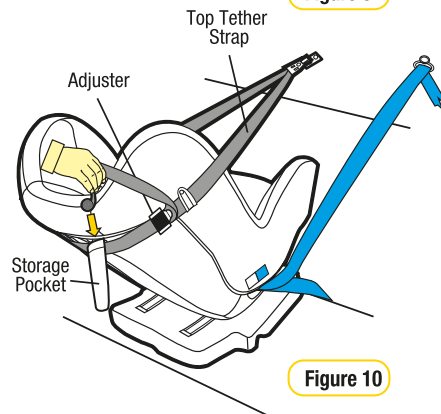

Figure 10

Use

Using Inbuilt Harness

Step 1: Ensure the restraint has been installed and set up as per "Set Up" and "Installation" (refer Page 11 - 19)

Step 2: To lengthen the harness "LIFT" the harness adjuster (refer Figure 2) whilst grasping both shoulder harness straps and pulling. Ensure shoulder straps are pulled equally on each side.

WARNING

To ensure infant's back is evenly supported, do not put more than one nappy on the baby and make sure the nappy is not thickly folded at the back.

Step 3: Place child in car seat with legs either side of the buckle, place harness over the shoulders and hips (refer Figure 3) .

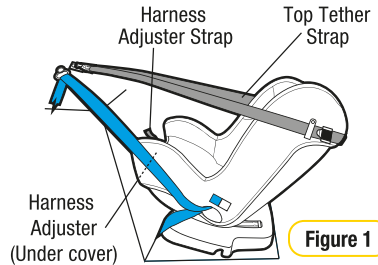

Figure 1

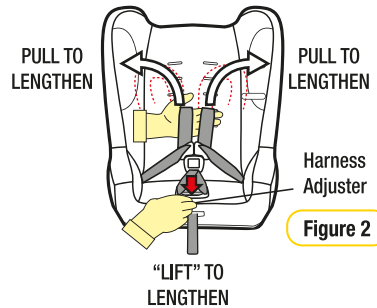

Figure 2

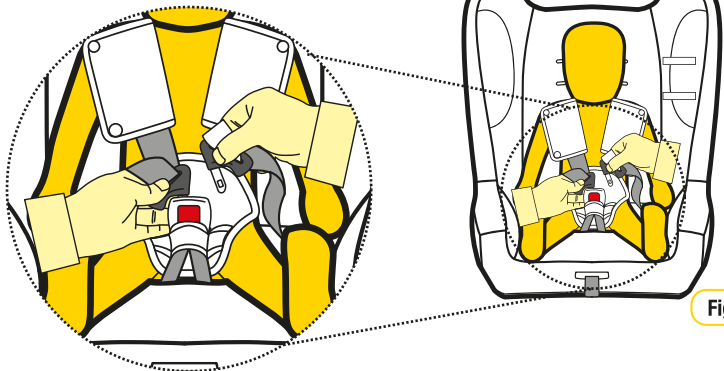

Figure 3

Use

Using Inbuilt Harness

Step 4: Insert either tongue into the buckle followed by the other tongue until a **“CLICK”** is heard. Should the second tongue not insert, press the red button and reinsert the tongues. Ensure secure engagement by pulling the harness strap (refer Figure 4).

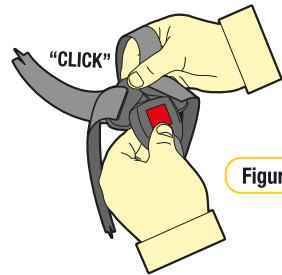
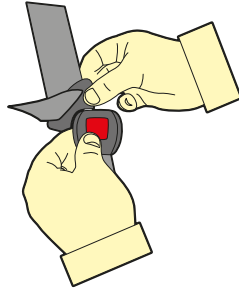
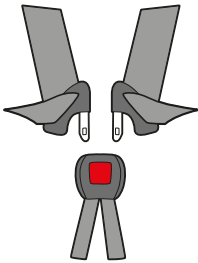

Figure 4



IMPORTANT

If no “Click” can be heard or a secure engagement cannot be achieved refer to Cleaning Buckle Harness page 41.

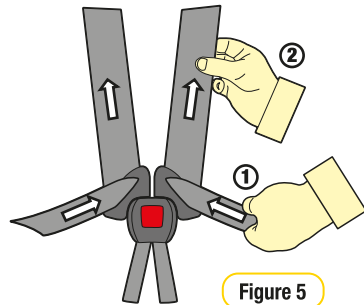

Figure 5

Step 5: Remove all of the slack for the harness lap straps by pulling shoulder straps (refer Figure 5), then pull the harness adjustment strap to adjust harness to a comfortable but firm fit (refer Figure 5 & 6).



WARNINGS

- **DO NOT LEAVE CHILDREN UNATTENDED IN THE CAR.**
- Fit the harness firmly to the child.
- **A LOOSE RESTRAINT OR HARNESS IS DANGEROUS.**

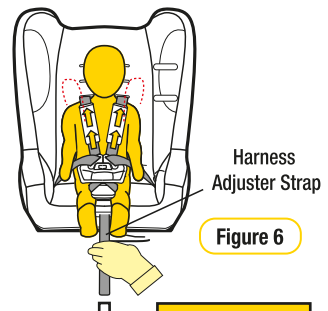

Figure 6

Harness Adjuster Strap

PULL TO TIGHTEN

REMOVE ALL SLACK FROM HARNESS

Use

Using in-built harness

IMPORTANT

- A **LOOSE HARNESS IS DANGEROUS.**
- The Padded Insert/s (if fitted) are designed to provide extra support and comfort for small babies. Discontinue use when the insert is a tight fit or creates discomfort for larger babies/children.
- Always adjust the height of the shoulder straps as the child grows.

NOTE: If Top Tether strap has been loosened to allow easier placing of the baby in the restraint, tighten the upper anchorage strap so it has no slack in it. **DO NOT TIGHTEN EXCESSIVELY.**

Step 6: Check the harness tightness by the **PINCH TEST**, this is achieved by pinching the harness webbing at the shoulders (refer Figure 7)

- If you can pinch the harness strap, tighten more.
- If your fingers slip off, then the harness is tight enough.

If required repeat Step 5.

Step 7: Pull to tighten to remove all the slack, from the upper anchorage strap. Do not overtighten as this could cause the restraint to lift off the vehicle seat (refer to Figure 8).

Step 8: Store any excess webbing, from the top tether strap, in the storage pocket provided on the restraint (refer Figure 9).

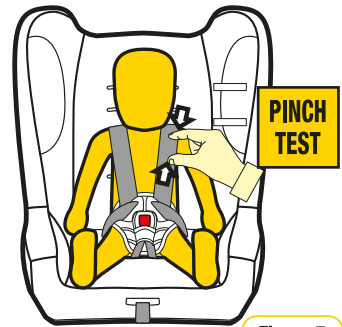

Figure 7

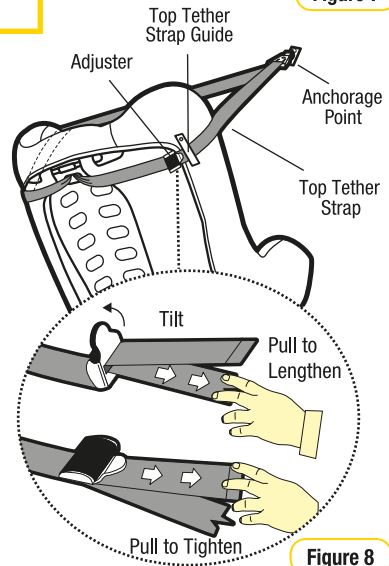

Figure 8

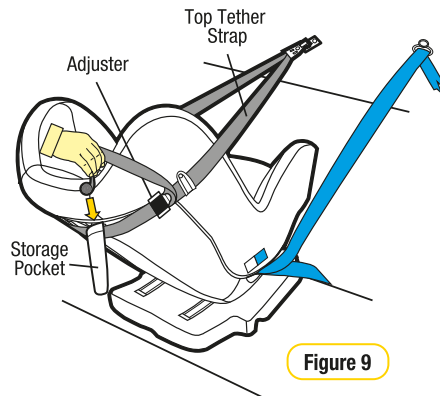

Figure 9

Use

To Release Infant

Step 1: To release your child from the restraint simply press the harness buckle and carefully remove your child from the restraint (refer Figure 1).

NOTE: If Top Tether strap has been loosened to allow easier placing of the baby in the restraint, always retighten the Top Tether strap so it has no slack in it. DO NOT OVERTIGHTEN.

For Ease Of Use

No need to disconnect the Upper Anchorage Strap.

To **access** your baby simply;

- Loosen upper anchorage strap (refer Figure 2).
- Lower strap out of way (refer Figure 3).

Reverse procedure when reseating the baby.



WARNING

- Always use a lap or lap-sash seat belt and top tether strap to attach the child restraint to the vehicle.
- Do not use the restraint without the top tether strap correctly attached and adjusted.
- Do not use on any vehicle seat which faces sideways or rearwards.
- IF AN AIRBAG IS FITTED IN THE SEATING POSITION WHERE THE CHILD RESTRAINT IS TO BE FITTED, FOLLOW THE VEHICLE MANUFACTURER'S WARNINGS AND INSTRUCTIONS.
- Do not use the restraint if the buckle is sluggish or does not provide an audible "Click" refer to Cleaning Instructions on page 41.

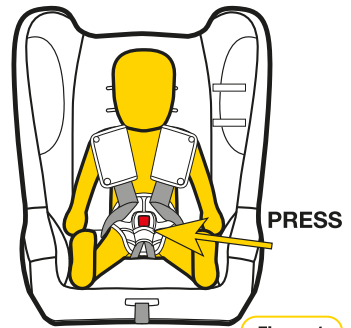

Figure 1

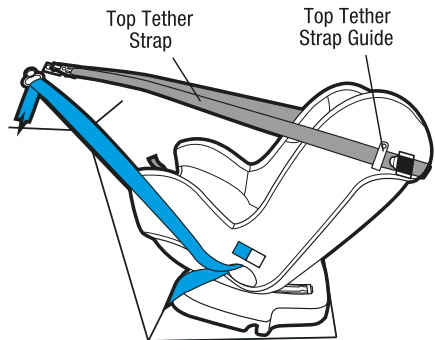

Figure 2

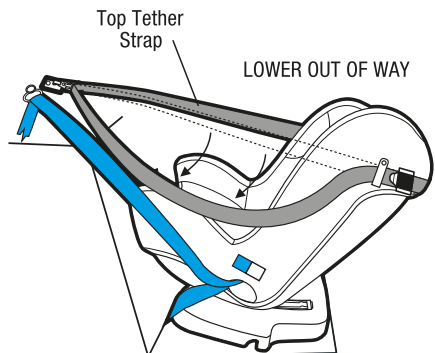

Figure 3

Child Car Seat (Forward Facing)

THE SUITABILITY OF THE CHILD RESTRAINT TO GROUPS OF CHILDREN

TYPE A4

To be used only in a rearward-facing position until the infant's shoulders either reach the lower shoulder height marker (approximately 12 months of age) or reach the middle height marker (approx 2 to 3 years of age).

TYPE B

Then to be used in a forward-facing position until the child's shoulders reach the upper shoulder height marker (approximately 4 years of age).

Continue to use this child restraint until the child shoulders reaches this limit.

Do not use forward-facing until child's shoulders are above the lower shoulder height marker.

Infants are at risk of serious injury if they face forward too early.

Children are at risk of serious injury if they move to booster seats too early.

Children who have outgrown this restraint are safest in a larger child restraint with an in-built harness or a booster seat until their shoulders reach the upper shoulder height marker of the restraint.

TO BE USED WITH A LAP-SASH/LAP-ONLY SEAT BELT IN THE BACK OF MOST CARS WITH FORWARD FACING SEATS.

The use of child restraints in the front seat may be restricted for children of specific ages by local legislation. Please check with your local Department of Transport for the specific seating locations of children using child restraints for their given ages.

IMPORTANT

- For a vehicle without a fixed parcel shelf an extension strap(s) may be needed. If so ring (02) 4728 8090 for nearest supply location.
- Seatbelt extenders are not recommended to be used if the seatbelt is not long enough to secure the child restraint. If seatbelts are too short then advice should be sought from a child restraint fitter and their recommendation be considered before using a seatbelt extender.

Shoulder Height Marker

Taller Toddler (using inbuilt harness)

Do not continue to use the restraint if the child's shoulder are above the Upper Label.

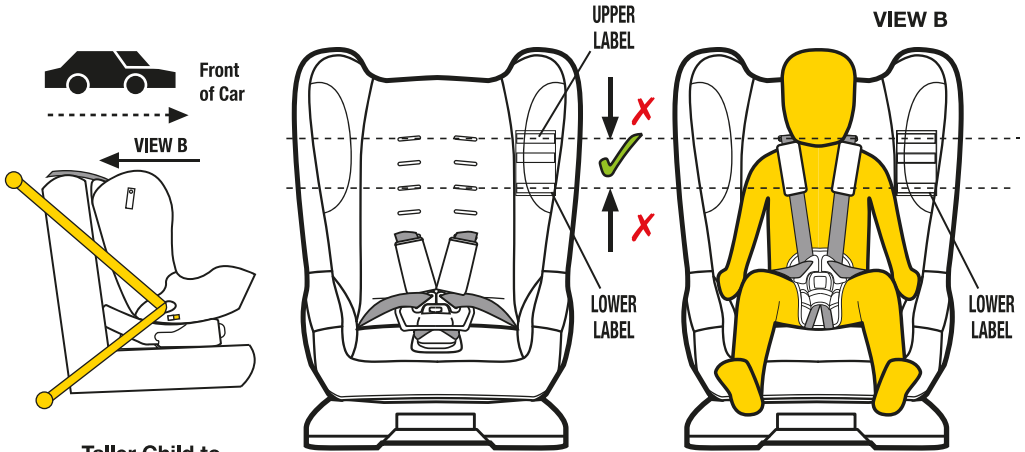

Taller Child to approximately 4 years of age

Continue to use this forward-facing child restraint until the child's shoulders **REACH** the Upper shoulder height marker (Upper Label).

UPPER LABEL (Forward-Facing)

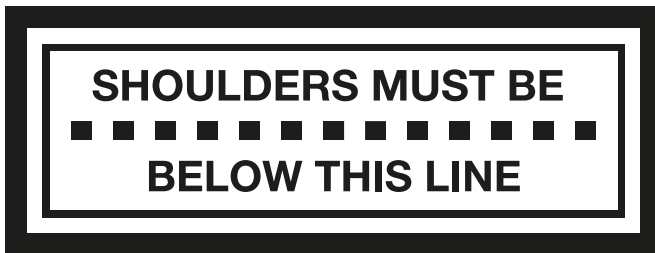

Children are at risk of serious injury if they move to booster seats too early.

Children that have outgrown the forward-facing child restraint are safest in a booster seat until their shoulders reach the upper shoulder height marker of the booster seat.

The child restraint is unsuitable for the occupant when the shoulders are above the upper marker. The child needs to be moved into the next form of child restraint eg. Type G, Type E booster seat or Type F booster seat when they reach the top shoulder height marker.

For the next child restraint refer to the Restraint Guide on page 5 and 27.

Next Restraint

Next Type of Restraint

Refer to the 'RESTRAINT GUIDE' for the selection for the most appropriate next restraint (refer Page 5). When the child has outgrown the child car seat, then you can use either of the following;

- **Convertible booster seat** - Type (B/E) integral harness until approx 4 years old and then as a booster seat with vehicle lap-sash seatbelt.
- **Booster seat** - Type (E) booster seat with vehicle lap-sash seatbelt.
- **Child Car Seat** - Type (G) harnessed child restraint suitable approx 6 months to 8 years.



Figure 1



Figure 2

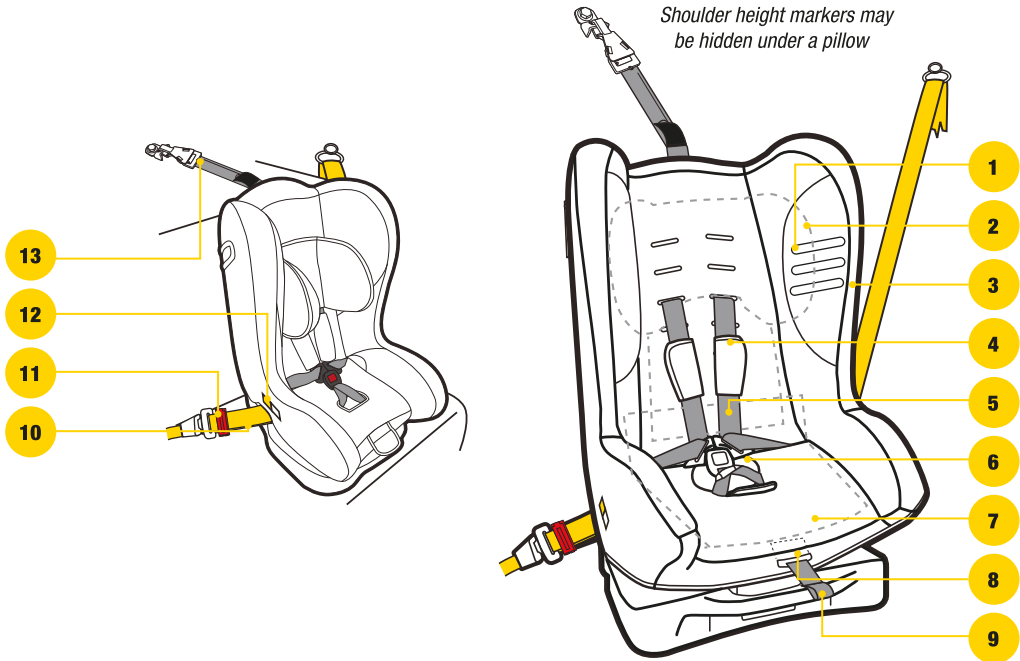

Figure 2

Model CS8313

Forward facing

Child Car Seat



1. Shoulder Height Markers
2. Pillow (if fitted)
3. Comfort Cover
4. Shoulder Pads
5. Harness Straps
6. Buckle Pad
7. Padded Insert (if fitted)
8. Harness Adjuster
9. Harness Adjustment Strap

10. Vehicle Seat belt
11. Safe Grip Red Belt Clamp (if supplied with restraint)
12. "FORWARD-FACING SEAT BELT PATH" Marker (each side of restraint - coloured yellow)
13. Top Tether Assembly
 - Tether Strap
 - Adjuster
 - Attachment Clip
 - Anchor Fitting + Attachment Hardware

NOTE: Padded inserts can vary according to model. For detailed description and method of attachment for padded accessories refer to Accessories on page 44.

IMPORTANT

- For a vehicle without a fixed parcel shelf an extension strap(s) may be needed. If so ring (02) 4728 8090 for nearest supply location (Refer page 43).
- Seat belt extenders should not be used if the seat belt is not long enough to secure the child restraint.

Set Up

Selection of appropriate padding combinations

Step 1: Determine whether your child requires the additional padding provided with this restraint, to ensure a safe and snug fit in the restraint. Refer to page 6 for suggested padding combinations.

Converting To Child Seat

Reclined Position

Step 1: Ensure the recline section is swung rearward (see Figure 1).

Step 2: At the front of the restraint is a red lever. Pull red lever forward and slide the seat to obtain the desired upright or reclined angle.

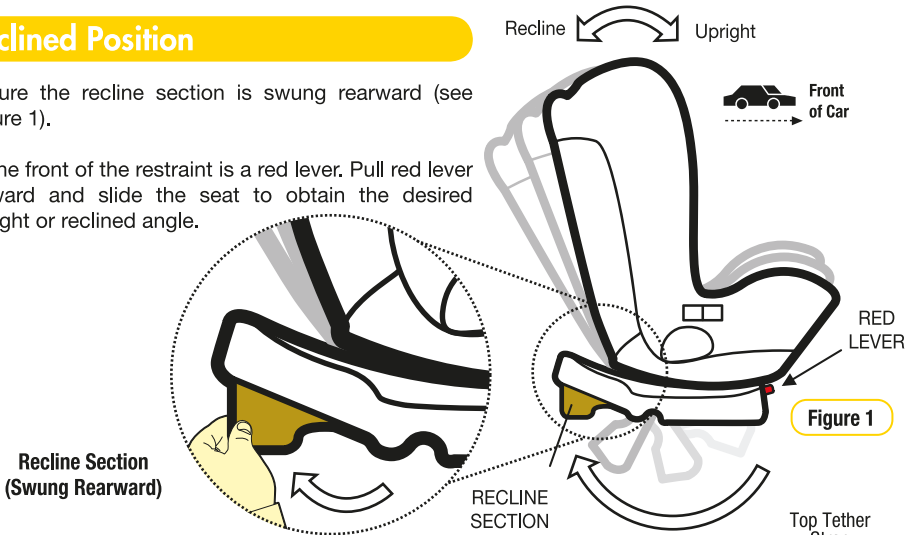

⚠ IMPORTANT

Refer to the shoulder height labels (As shown on pages 25 and 26).

Adjuster Assembly Location

Forward Facing (Type B)

Step 1: Pull excess strap through the top section ① whilst feeding the adjuster section ② towards the seat (see Figure 2).

Step 2: Continue to shorten until you have reached the desired position at the rear of the restraint (see Figure 3).

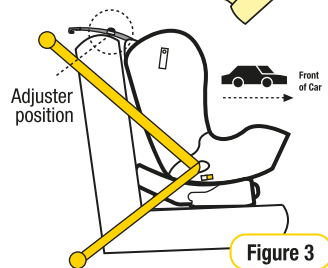
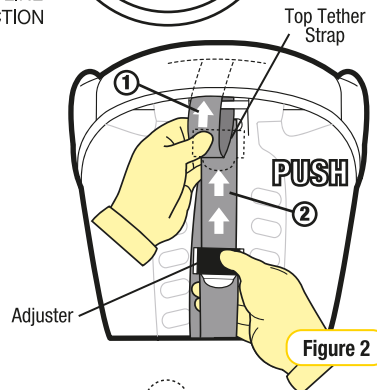

Setup

Shoulder Height

The correct height for the shoulder straps is very important for the optimum performance of the restraint. The shoulder strap slots used in forward facing position are the upper and middle positions.



IMPORTANT

The shoulder straps must be in the slots which are nearest to the child's shoulders, but not more than 25mm below the child's shoulders.

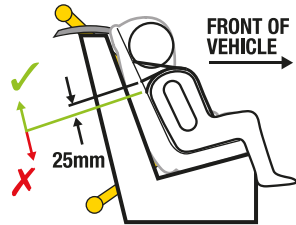

The shoulder strap slots used in Child Seat mode are above the lower shoulder height markers (refer Pages 31 & 32).

Setup

Shoulder Height

Step 1: Loosen harness to allow spreader plate to rise from under the restraint. Turn the restraint so that the back of the seat is facing you.

Step 2: Remove each shoulder harness through the gates in the spreader plate (see Figure 1 & 4).

Step 3: Pull the shoulder harness straps through the shoulder slot holes in the seat body and cover. They are now loose in the front of the seat.

Step 4: Push the ends of the shoulder harness straps through the appropriate shoulder slot holes in the cover and seat body for the child's shoulder height.

NOTE: Ensure the harness straps are not twisted.

Step 5: The shoulder harness straps go directly from the shoulder slot holes to the spreader plate. Thread each shoulder harness strap back onto the metal spreader plate through the gate (see Figure 4).

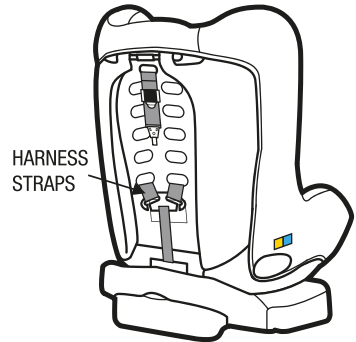

Figure 1

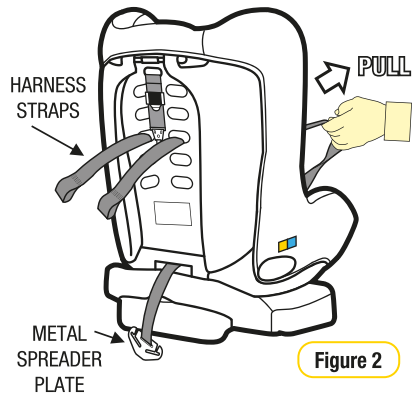

Figure 2

! IMPORTANT

The shoulder straps must be in the slots which are nearest to the child's shoulders, but not more than 25mm below the child's shoulders.

With the child correctly sitting in the restraint, check which set of slots (in the plastic shell of the restraint) are level with but not more than 25mm below the child's shoulders.

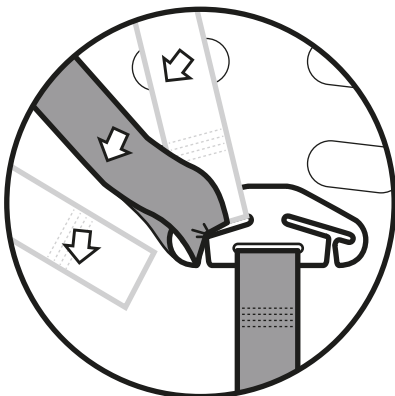

Figure 4

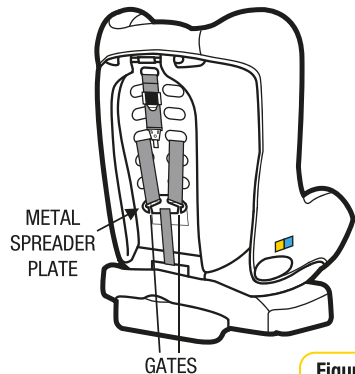

Figure 3

Installation

Installing Using Vehicle Seatbelt

Step 1: Place the restraint in desired upright or reclined position, with the back against the back of the vehicle seat, directly in line with the anchorage point (refer Figure 1).



IMPORTANT

Ensure that you use the
FORWARD-FACING BELT PATH
identified by the following label.



Figure 1

Installation

Installing Using Vehicle Seatbelt

Step 2: Feed adult lap or lap/sash belt through the belt path opening, ensure the seat belt is under the cover & between the layer of foam and the plastic seat base. (refer Figure 2 & 3).

Engage the buckle and tongue assembly (listen for a **“CLICK”**). Check the buckle engagement with a gentle pull.



WARNING

- Always use Top Tether strap to attach the child restraint to the vehicle.
- Do not use the restraint without the Top Tether strap correctly attached and adjusted.
- Do not use on any vehicle seat which faces sideways or rearwards.
- **IF AN AIRBAG IS FITTED IN THE SEATING POSITION WHERE THE CHILD RESTRAINT IS TO BE FITTED, FOLLOW THE VEHICLE MANUFACTURER’S WARNINGS AND INSTRUCTIONS.**
- Fit the restraint firmly to the car seat.

Pass lap and sash belt through the seat. Note: Ensure the belts are under foam padding.

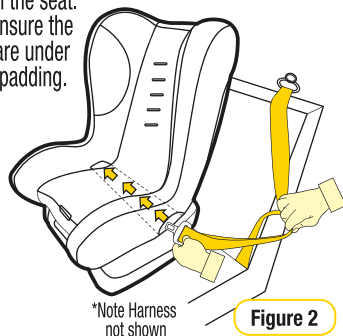

Figure 2

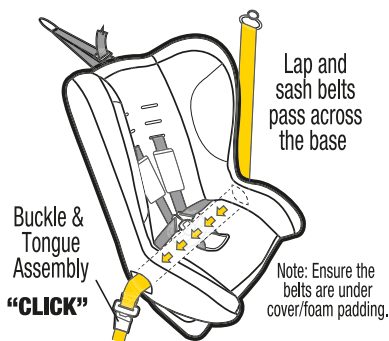

Figure 3

Step 3: Push down on the base of the restraint (with knee or hand) whilst pulling the sash section of the vehicle belt firmly up in direction of the yellow arrow in Figure 4. (This will tighten the lap belt across the seat base).

Whilst continuing to pull the sash section up, attach the **Safe Grip** red belt clamp on the sash section **ONLY** as close as possible above the buckle tongue assembly. (Refer to Figure 5 and Instruction for installing the **Safe Grip** red clamp below)

Step 4: Ensure the excess slack in the sash belt, is fed back towards the seat belt.

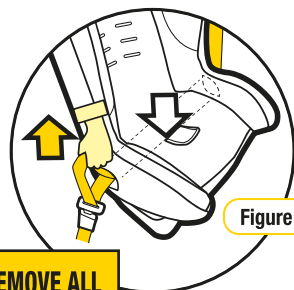

Figure 4

REMOVE ALL SLACK FROM SEATBELT

Installation

Installing Using Vehicle Seatbelt

Safe Grip (if supplied)

*Can be purchased separately visit
<http://store.infasecure.com.au/>

SAFE GRIP BELT CLAMP

The **Safe Grip** (red belt clamp) **locks the lap belt** to ensure a firm installation, and avoids slack in the lap belt.

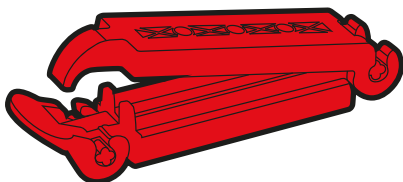

To install the **Safe Grip** (red belt clamp), open it and clamp the “sash section” **ONLY** of the vehicle seat belt by closing the barrel section of the red belt clamp in the direction of arrow 1 in Figure 5 and then locking with the toggle section by pushing in the direction of arrow 2 in Figure 5 when the **Safe Grip** (red belt clamp) is secured in place, the lap section is now tightly holding your child restraint in place, independent of the sash section. The **Safe Grip** (red belt clamp) must be removed when the child restraint is not installed to allow other users to use the seat belt as a lap/sash seat belt. Always keep the **Safe Grip** (red belt clamp) in pocket provided when not in use.

NOTE: Do not place the **Safe Grip** (red belt clamp) around both the lap and sash sections of the belt. This could cause the **Safe Grip** (red belt clamp) to break.

Adjusting Recline Angle

NOTE: To adjust the recline angle of the child seat refer to “Converting to Child Seat” on page 29.

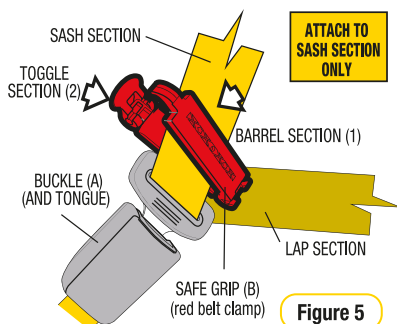

Figure 5

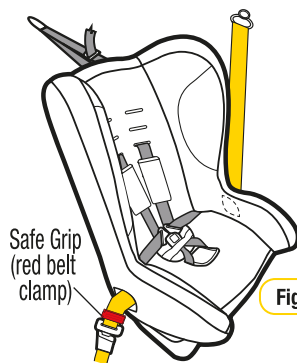

Figure 6

Installation

Installing Using Vehicle Seatbelt

Note: If no upper anchorage fitting is available refer to Pages 47 & 48.

Step 5: Hook the attachment clip to the anchor fitting. Ensure there are no twists in the top tether strap (refer to Figure 7).

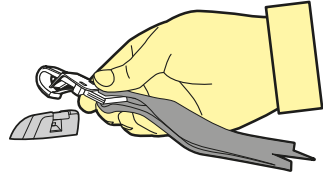
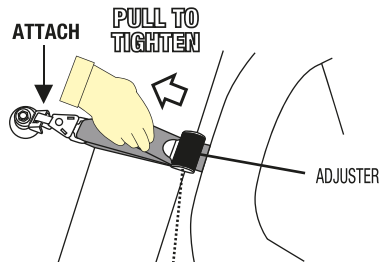

Figure 7

Step 6: Pull to tighten to remove all the slack, from the upper anchorage strap. Do not overtighten as this could cause the restraint to lift off the vehicle seat (refer to Figure 8).



Step 7: Store any excess webbing, from the top tether strap, in the storage pocket provided on the restraint (refer to Figure 9).

NOTE

FOLLOWING THE INSTALLATION OF THE CHILD RESTRAINT A SMALL AMOUNT OF MOVEMENT IS DEEMED ACCEPTABLE.

CAUTION: CHILDREN CAN BE INJURED OR RESTRAINTS AND TOP TETHER STRAP DAMAGED BY UNSECURED CARGO IN A COLLISION. SECURE OR REMOVE HAZARDOUS CARGO BEFORE USING THIS CHILD RESTRAINT.

Always secure the loose end of the top tether strap to prevent it hanging out of the car or being accessible by the child.

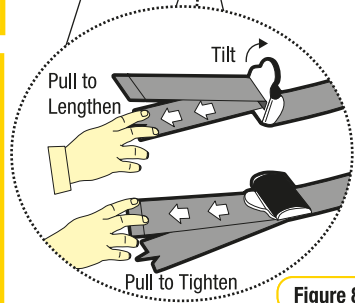

Figure 8

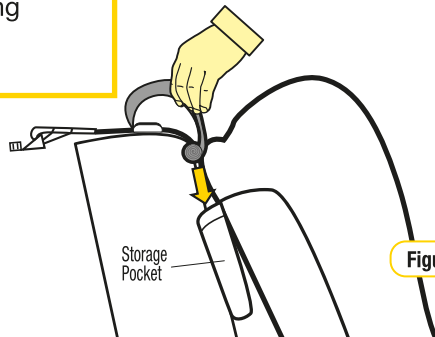

Figure 9

Use

Using Inbuilt Harness

- Step 1:** Ensure the restraint has been installed and set up as per "Set Up" and "Installation" (refer Page 29 - 35).
- Step 2:** To lengthen the harness "LIFT" the harness adjuster (refer Figure 1) whilst grasping both shoulder harness straps and pulling. Ensure shoulder straps are pulled equally on each side.
- Step 3:** Place child in car seat with legs either side of the buckle, place harness over the shoulders and hips. (refer Figure 2).

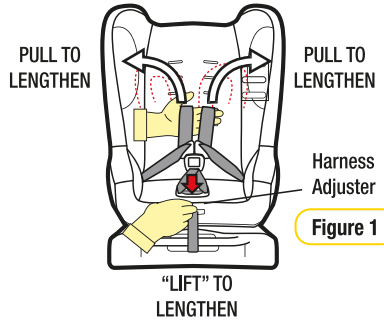

Figure 1

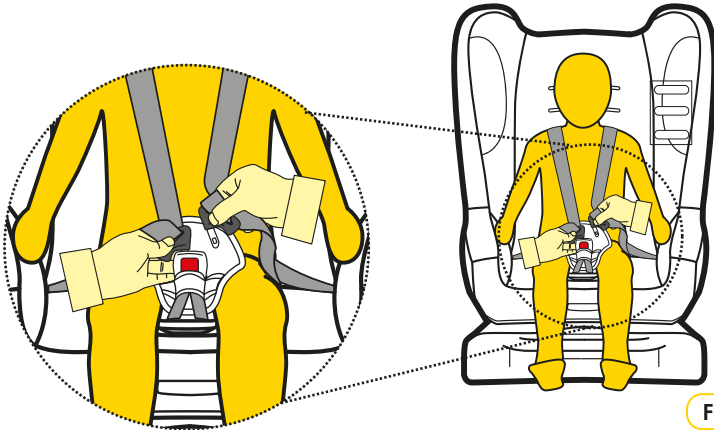

Figure 2

Use

Using Inbuilt Harness

Step 4: Insert either tongue into the buckle followed by the other tongue until a **“CLICK”** is heard. Should the second tongue not insert, press the red button and reinsert the tongues. Ensure secure engagement by pulling the harness strap (refer Figure 3).

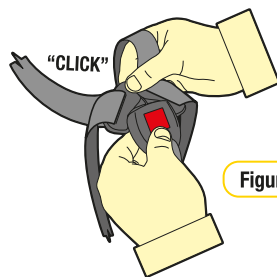
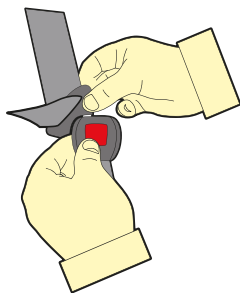
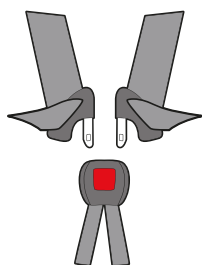

Figure 3



IMPORTANT

If no “Click” can be heard or a secure engagement cannot be achieved refer to Cleaning Buckle Harness page 41.

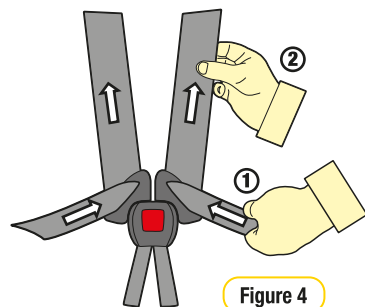

Figure 4

Step 5: Remove all of the slack for the harness lap straps by pulling shoulder straps (refer Figure 4), then pull the harness adjustment strap to adjust harness to a comfortable but firm fit (refer to Figure 4 & 5).



WARNINGS

- **DO NOT LEAVE CHILDREN UNATTENDED IN THE CAR.**
- Fit the harness firmly to the child.
- **A LOOSE RESTRAINT OR HARNESS IS DANGEROUS.**

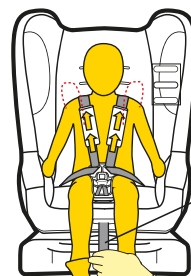

Harness Adjuster Strap

Figure 5

PULL TO TIGHTEN

REMOVE ALL SLACK FROM HARNESS

Use

Using in-built harness

Step 6: Check the harness tightness by the **PINCH TEST**, this is achieved by pinching the harness webbing at the shoulders (refer Figure 6)

- If you can pinch the harness strap, tighten more.
- If your fingers slip off, then the harness is tight enough.

If required repeat Step 5.



IMPORTANT

- **A LOOSE HARNESS IS DANGEROUS.**
- The Padded Insert/s (if fitted) are designed to provide extra support and comfort for small babies. Discontinue use when the insert is a tight fit or creates discomfort for larger babies/children.
- Always adjust the height of the shoulder straps as the child grows.

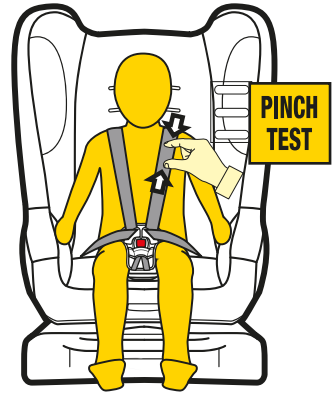

Figure 6

Adjusting Recline Angle

NOTE: To adjust the recline angle of the child seat refer to “Converting to Child Seat” on page 29.

Step 1: First loosen the seatbelt assembly, the Safe Grip Belt Clamp may need to be removed.

Step 2: At the front of the restraint is a red lever. Pull red lever forward and slide the seat to obtain the desired upright or reclined angle (refer Figure 1).

Step 3: Reinstall the seatbelt and Safe Grip Belt Clamp (refer Page 33 & 34).

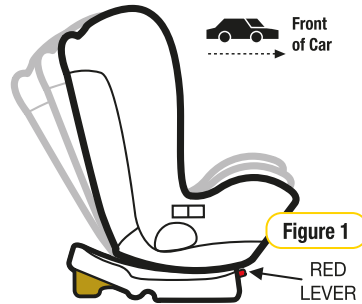

Figure 1

To Release Child

Step 1: To release your child from the restraint simply press the harness buckle and carefully remove your child from the restraint (refer Figure 1).

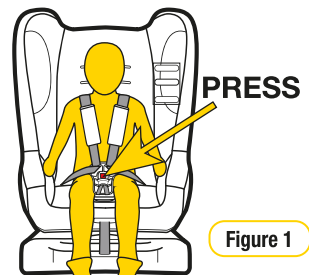
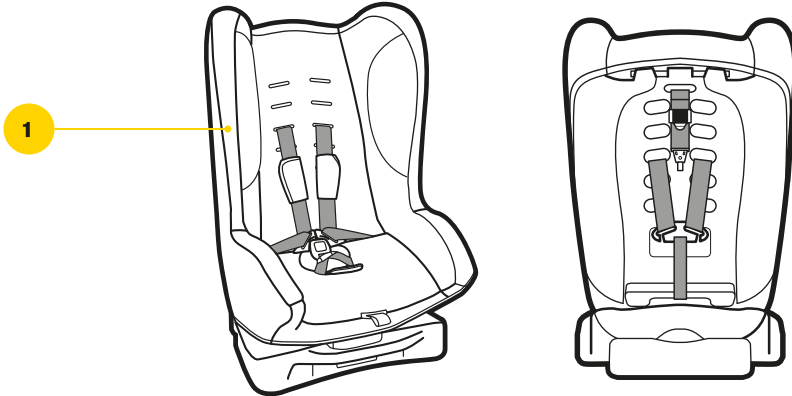

Figure 1

Care of Restraint

The child restraint cover has been manufactured to meet the Australian Standards requirements for flammability and toxicity to ensure your child's safety. The cover has also been designed to provide your child with comfort and support.



1. Main Cover

VERY IMPORTANT

Only replace the cover with a InfaSecure supplied replacement cover with identical shoulder height markers or a replacement cover meeting AS/NZS 8005.

Care and Maintenance

Regular care of the restraint will ensure safety of your child.

- Check the webbing for fraying.
- Check the upper anchorage attachment clip to ensure retainer clip is still present.
- Ensure there are no cracks in moulding or the plastic moulding.
- Check the buckles “click” when you engage tongues and is not sluggish or sticky in operation.
- Ensure the buckle is free of fluff, liquid, or other matter that may enter the buckle slots. Clean the buckle if it is sluggish to engage (refer Cleaning Buckle Page 41)
- Check the harness adjuster is operating and is clamping the webbing
- If any part of the restraint is cracked or broken, seek repair immediately or replace the child restraint.

Cleaning



IMPORTANT

Use only mild soap and water to clean all parts of the CS8313 Convertible Car Seat.
Do not use chemicals or cleaning agents
Cold water only to be used and to be rinsed well
Do not dry clean or tumble dry
Do not bleach.

Covers

The restraint has a flame retardant cover which is removable for cleaning. Cleaning instructions are on the care label attached to the cover. If a fluffy cover is fitted, then washing the cover prior to use will remove excess fluff.

The cover has been designed to protect your child when seated in the restraint. Care should be taken, if children either eat or drink while in the restraint, as some food or drink products may cause damage or marking to the cover. Wash or clean immediately. Do not pull sticky items from covers as the cover may be damaged - soak in water and gently remove.

Only machine wash on gentle cycle (hand washing is recommended). When washing the covers, ensure the hook and loop attachment strips are connected to eliminate other materials or garments being caught. Ensure that the hook and loop attachment strips are free of lint, this will ensure a positive engagement.



IMPORTANT

For **Velour** or **Leatherette** fabric only sponge clean with a damp cloth.

Seat + Hardware

Use only mild soap and water to clean all webbing, metal and plastic parts of the restraint using a damp cloth.
Do not use chemicals or cleaning agents.

Harness Straps

Use only mild soap and water to clean all straps, using a damp cloth the harness straps can be soaked, however they must be thoroughly dried without excessive heat (never tumble dry). The harness straps should not be placed in a washing machine as this may cause damage to the stitching or even damage your washing machine.
Do not use chemicals or cleaning agents.

Cleaning

Harness Buckle

If sticky liquids such as baby formula, fruit juice, etc. get inside your Harness Buckle, it may become sluggish. An indication of a sluggish Harness Buckle is that you cannot hear a **“CLICK”** when engaging the Harness Tongues. To restore the Harness Buckle to good working order it needs to be cleaned as follows:

Step 1: From the underside of the restraint pull each crotch 3-bar slide then turn 3-bar slide and push through each slot to remove the Harness Buckle from the restraint (refer Figure 1).

Step 2: Place the Harness Buckle under warm (max. 40 degrees Celsius) running water as shown below. Let the water run through the mouth of the buckle for five minutes (refer Figure 2).

Step 3: Engage and disengage the Harness Tongues and Buckles several times until a strong audible **“CLICK”** is heard when inserting the last tongue (refer Figure 3).

Step 4: If you still cannot hear a strong audible click after engaging the Harness Tongues and Buckle, then repeat cleaning several times. If the Harness Buckle cannot be returned to its original working condition then contact InfaSecure Customer Service 02 4720 8090.

Step 5: Refit the harness buckle to the restraint with the red button facing out and feeding each 3-bar slide through appropriate slot. Always ensure the webbing crotch straps are thoroughly dried before installing.

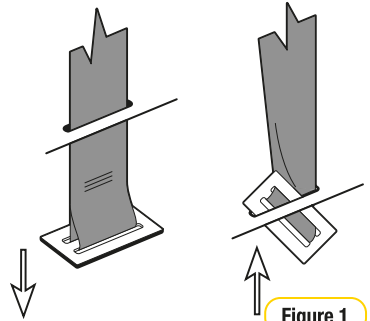

Figure 1

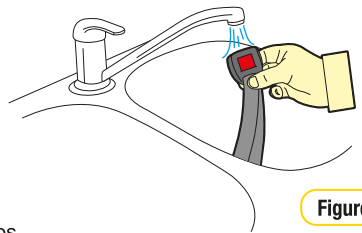

Figure 2

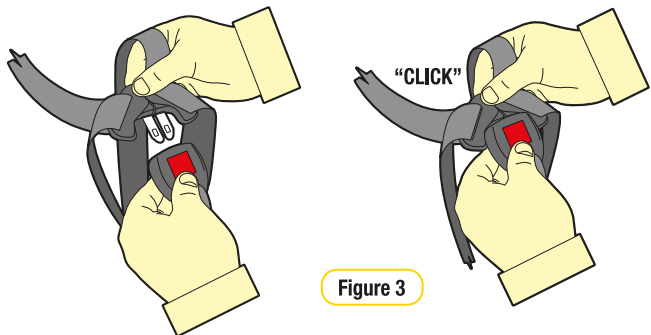

Figure 3

Remove & Replace Covers

Main Cover

Step 1: Loosen harness to allow spreader plate to rise from under the restraint. Turn the restraint so that the back of the seat is facing you.

Step 2: Remove each shoulder harness through the gates in the spreader plate (see Figure 1 & 4).

Step 3: Pull the shoulder harness straps through the shoulder slot holes in the seat body and cover. They are now loose in the front of the seat.

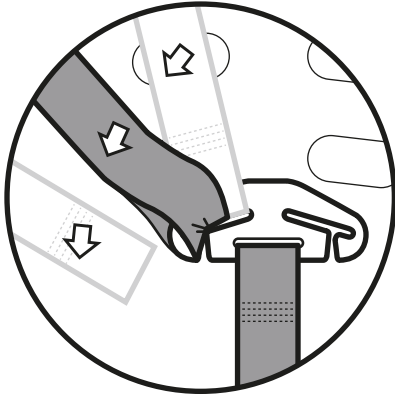

Figure 3

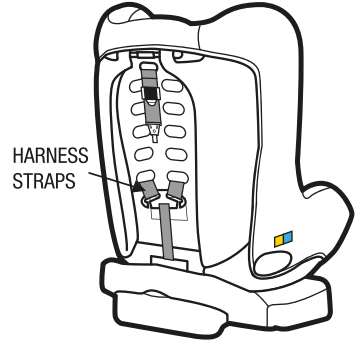

Figure 1

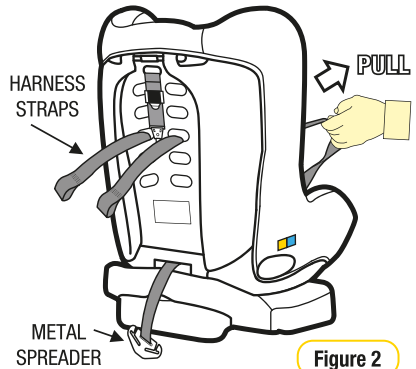

Figure 2

Step 4: Unclip the press studs located;

Step 5: **1** back of seat

2 both sides of restraint

Step 6: Remove cover

*Replace in reverse.

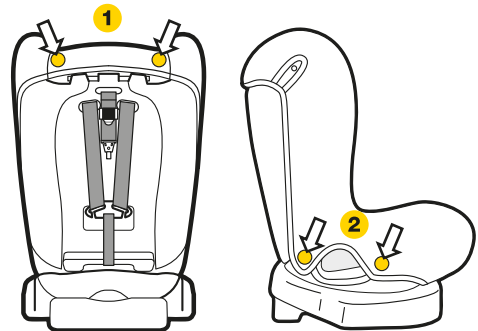
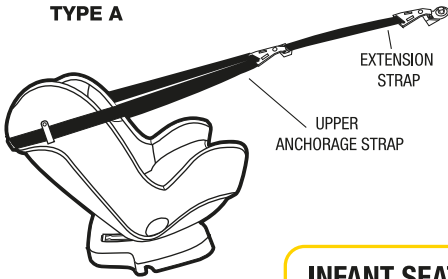

Figure 4

Extension Straps

If required contact InfaSecure for nearest supply location. Extension straps, not included in this package, may be required for vehicles without a fixed parcel shelf.



Re order Line Numbers

CS111 300mm Length

CS112 600mm Length

CS113 200mm - 900mm
Adjustable Length

If required contact Infa Secure
Customer Service 02 4728 8090
for nearest supply location.

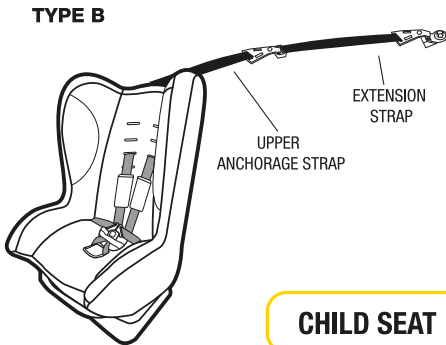

Accessories

Follow the instructions covering the use of accessories provided with this child restraint or spare parts provided by InfaSecure for this restraint.

IMPORTANT

Use of unauthorised aftermarket accessories (i.e items not provided in this box with the child restraint), can reduce the safety provided by the child restraint and may cause injury or death.

PADDED INSERTS (if fitted)

The padded inserts are designed to add extra comfort for your child.

- Step 1:** Press to release Buckle tongues.
- Step 2:** Open the “press studs” and position the padded insert in the seat.
- Step 3:** Pass the harness straps over the insert and connect the “press studs”.
- Step 4:** Pull the Buckle and leg straps through the slot or opening in the insert.
- Step 5:** Connect both tongues into the buckle.

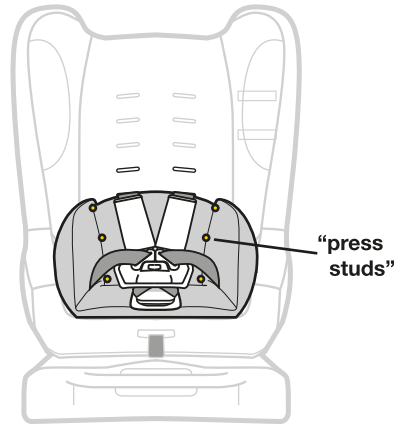

BUCKLE PAD (if fitted)

The buckle pad is designed to add extra comfort for baby or child.

- Step 1:** Position the buckle pad behind the buckle and clip in the front. The release button should be clearly visible.

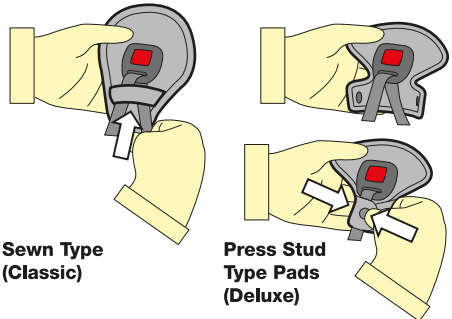

**Sewn Type
(Classic)**

**Press Stud
Type Pads
(Deluxe)**

Accessories

SHOULDER PADS (if fitted)

The shoulder pad is designed to add extra comfort for baby or child.

Classic

- Step 1:** Loosen harness to allow spreader plate to rise from under the restraint. Turn the restraint so that the back of the seat is facing you.
- Step 2:** Remove each shoulder harness through the gates in the spreader plate (refer Figure 1 & 2).
- Step 3:** Pull the shoulder harness straps through the shoulder slot holes in the seat body and cover. They are now loose in the front of the seat (refer Figure 2).
- Step 4:** To attach shoulder pads, slide the shoulder pad over the harness straps (refer Figure 3).
- Step 5:** Rethread harness straps (in applicable slots) as per Steps 1 to 3 above.

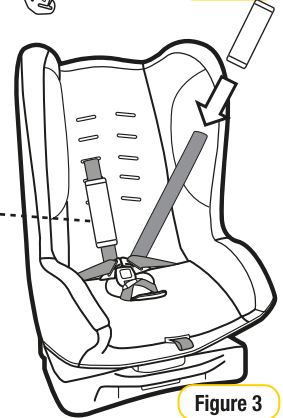
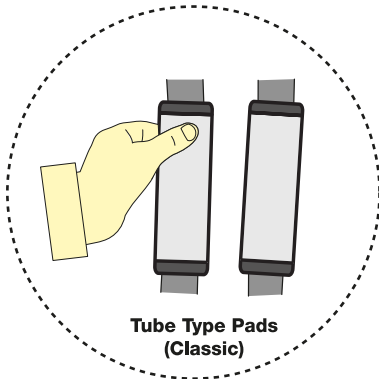
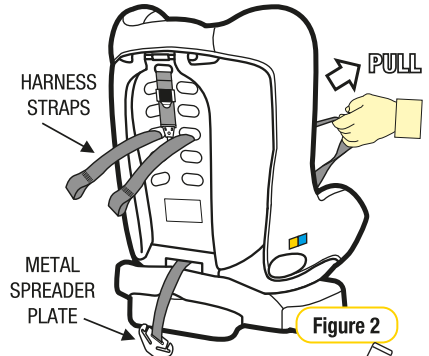
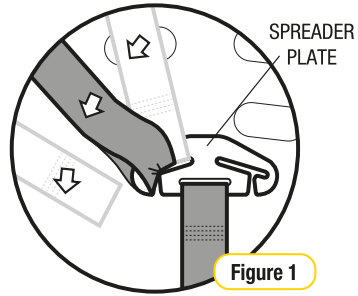

Deluxe

- Step 1:** Separate press-studs and remove the shoulder pads from harness
- Step 2:** To attach shoulder pads, ensure press studs face away from the child and re-attach.

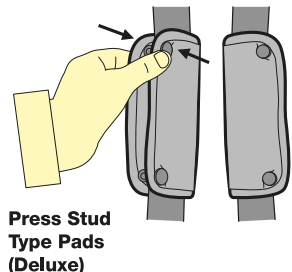

Accessories

HEAD PILLOW/INFANT PILLOW (if fitted)

The head pillow/infant pillow (if fitted) is designed to provide extra comfort.

- Step 1:** Position the bottom of the pillow's side wings at the top of the child's shoulders.
- Step 2:** Feed the upper and lower pillow straps through the nearest slots.
- Step 3:** Thread the strap through the plastic buckle (or tie a knot) and adjust for a firm fit, which ever is applicable.

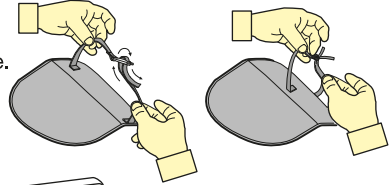
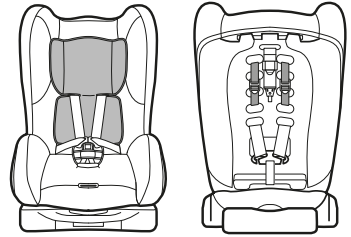

SEAT PROTECTOR (if fitted)

The seat protector is designed to protect your car's seat.

STANDARD

- Step 1:** Position the front flap with pockets, at the front of the rear seat and position the mat rearwards to obtain a flat fit.

FULL LENGTH

- Step 1:** Position the front flap with pockets, at the front of the rear seat and position the mat rearwards to obtain a flat fit. (If required an additional flap has been provided to tuck in between the seat back & cushion)
- Step 2:** Position the back section up the seat back and use the plastic buckle & webbing strap to attach around the vehicle seat headrest (if the rear vehicle seat does not have a headrest then the strap could be used to attach around the child seats top tether after you have installed the child seat).

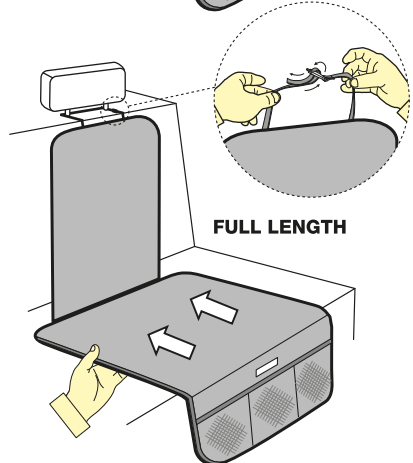
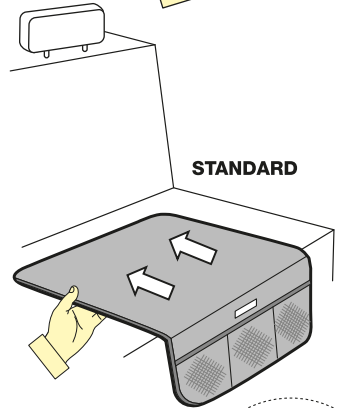

Anchorage Fittings

Some vehicles may have an anchor fitting already fitted by the vehicle manufacturer.

If no anchorage points can be found refer to the vehicle manufacturer, or an authorised child restraint fitting station for the best location of an anchorage point.

Refer to the vehicle owners handbook or child restraint fitting station for the possible use of spacers.

Some vehicles may require the use of additional extension straps (not supplied with this child restraint)

If so ring InfaSecure on (Aust) (02) 4728 8090 for nearest supply location.

ADDITIONAL EXTENSION STRAPS AVAILABLE:
 CS111 300mm Extension strap
 CS112 600mm Extension strap
 CS113 200 - 900mm Adjustable Extension strap

! WARNINGS

- Top tether strap and attachment clip must always be used
- Always ensure that the upper attachment clip is correctly engaged to the anchor fitting
- THIS RESTRAINT MUST BE ATTACHED TO A CHILD RESTRAINT ANCHORAGE POINT IN THE CAR. REFER TO CAR OWNER'S HANDBOOK FOR LOCATION OF ANCHORAGE POINTS. REFER TO A CHILD RESTRAINT FITTING STATION IF NO CAR ANCHORAGE POINTS ARE IN THE MOTOR CAR.
- THIS RESTRAINT IS NOT SUITABLE FOR USE WHERE TOP TETHER STRAP MAY FALL INTO A SPLIT IN THE SEAT BACK OR OFF THE SIDE OF THE SEAT.

For cars fitted with a child restraint anchorage point

THIS RESTRAINT MUST BE ATTACHED TO A CHILD RESTRAINT ANCHORAGE POINT IN THE CAR. LOCATE THE ANCHORAGE POINT BEHIND THE REAR SEATING POSITION CONSULT THE CAR OWNER'S HANDBOOK FOR LOCATION OF ANCHORAGE POINTS. REMOVE THE THREAD PLUG FROM THE PARCEL SHELF/FLOOR/ROOF AND INSTALL THE ATTACHMENT BOLT AS SHOWN IN FIGURE 1A & 1B.

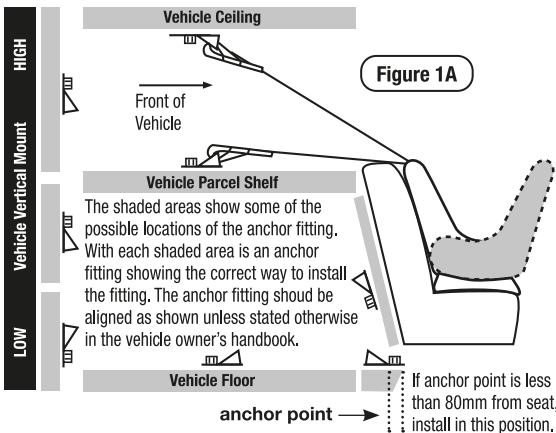

WARNING: If A.D.R. anchorage point is recessed, spacer(s) may be required. Spacer Part No's are as follows:
 10mm - CCS001;
 5mm - CCS002

UPPER ANCHORAGE FITTINGS

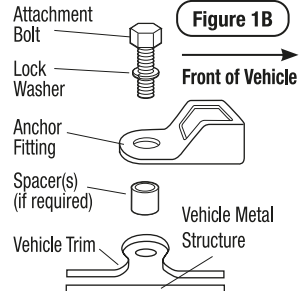

CAUTION: DO NOT OVERTIGHTEN ATTACHMENT BOLT. MAXIMUM TORQUE IS 20NM.

Anchorage Fittings

For cars not fitted with a child restraint anchorage point

For Sedans Only

Drill a 9mm diameter hole in the parcel shelf on the centre line of the seating position as shown in Figure 1C. Hole must be no closer than 200mm from the front of the back seat. Install the anchor bolt as shown in Figure 1D.

Note to Queensland purchases: The installation of anchorage points must be approved by authorised officers appointed by Queensland Transport. Authorised officers can be sourced from all Queensland Transport Customer Service and Queensland Ambulance Service Centres.

For Vehicles other than Sedans

In Australia, consult your nearest child restraint fitting station of traffic authority for vehicle inspection to find the best, correct position for the placement of the anchorage point, and for the correct attachment bolt length use of spacers.

In New Zealand consult the agent of the vehicle.

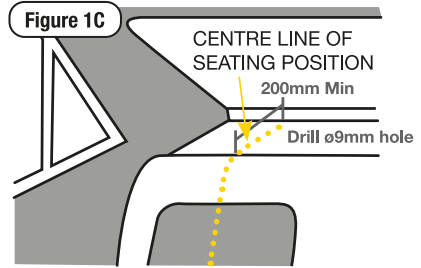

UPPER ANCHORAGE FITTINGS FOR SEDANS ONLY

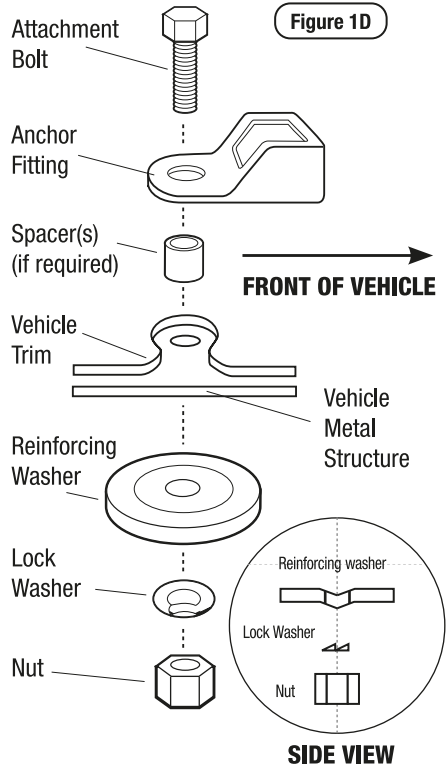

WARNINGS

CHILD RESTRAINTS MUST NOT BE ATTACHED TO UNSOUND METAL OR WOOD OR SYNTHETIC STRUCTURES. WHEN DRILLING THE 9MM HOLE DO NOT DRILL THROUGH FUEL LINES, FUEL TANKS, ELECTRICAL WIRING OR RADIO SPEAKERS. WEBBING STRAPS MUST BE PROTECTED FROM SHARP CORNERS AND EDGES.

THE ANCHOR FITTING MUST BE USED ONLY AS DESCRIBED ABOVE. IT MUST NOT BE HOOKED ONTO ANY OTHER OBJECT.

Insurers Information

If your restraint has been involved in a severe crash, you should destroy the restraint even if no damage is obvious. Some insurance companies offer vehicle insurance which covers or partially covers the replacement of your child restraint. Contact your insurance company for further details.

Your insurance company may require you to keep the child restraint for assessment, but do not use the child restraint after a severe crash. To assist you in making an accident insurance claim cut the following statement and include it with your claim.

NOTICE TO INSURANCE COMPANY CHILD RESTRAINT INVOLVED IN AN ACCIDENT

All InfaSecure child restraints are manufactured to Australian/New Zealand Standards AS/NZS1754 which requires us to advise users of child restraints to "Destroy the entire restraint if it has been in use in a severe crash, even if no damage is obvious".

The Australian/New Zealand Standards committee, advise that this statement applies whether a child was in the child restraint or not. We consider a "severe crash" as being one where the main body structure of the vehicle is distorted.

There is no method of determining if the restraint has been damaged and we concur with the Australian/New Zealand Standards in recommending destruction of the child restraint.

This notice is to advise you of the requirements of the Australian/New Zealand Standards and our obligation in complying with the standards.

Please assist the owner of this restraint in their claim.

INFASECURE PTY LTD ABN: 52 149 173 660

Head Office and Registered Address
110-114 Old Bathurst Rd, Emu Plains, NSW 2750
P.O. Box 487, Emu Plains, NSW 2750

Head Office
P: 02 4728 8000
F: 02 4728 8040
www.infasecure.com.au



LIFETIME WARRANTY

ON SUPER STRONG BLOW MOULDED SHELL PRODUCTS

Register your product to receive **lifetime warranty***, product updates and information.

 Please visit [infasecure.com.au/warranty-registration](https://www.infasecure.com.au/warranty-registration) to register your product.

Infasecure Warranty

Infasecure Pty Ltd warrants this product for twelve months from the date of purchase against failure due to manufacturing faults or faulty materials. Misuse, accidental damages, normal wear and tear are not covered by this warranty.

When used for commercial use the period is limited to six months. "Our goods come with guarantees that cannot be excluded under the Australian Consumer Law. You are entitled to a replacement or refund for a major failure and for compensation for any other reasonably foreseeable loss or damage. You are also entitled to have the goods repaired or replaced if the goods fail to be of acceptable quality and the failure does not amount to a major failure."

Additional Warranty on Blow Moulded Child Restraints

Our blow moulded child restraints are covered against faulty materials and manufacturing when used under normal conditions and according to the instructions.

In the unlikely case that you do have a fault in relation to material quality or manufacturing that restricts your ability to use your Child Restraint normally, we will repair or replace the product within the following warranty periods from date of purchase:

- 12 month warranty for material and fabrics
- 2 year warranty for straps and webbing
- 5 year warranty for hardware and fittings
- Lifetime warranty* on the manufacturing of the seat moulding

Please read your instruction manual carefully before using any of our products. The above express warranties do not apply where a failure or defect results from improper care, misuse or from normal wear and tear.

Refer to website for more details: www.infasecure.com.au

*Lifetime warranty refers to the life span of the seat which is 10 years from the Date of Purchase.



CHILD RESTRAINT SAFETY PARTNER



“ We are proud to be working with The Wiggles. With their help, we are able to reach more young families with much needed information and advice to keep our little ones safe. ”

INFASURE PTY LTD ABN: 52 149 173 660

Head Office and Registered Address
110-114 Old Bathurst Rd, Emu Plains, NSW 2750
P.O. Box 487, Emu Plains, NSW 2750

HEAD OFFICE

Phone No: +61 2 4728 8000
Fax No: +61 2 4728 8040
Email: admin@infa.com.au

CUSTOMER SERVICE

Phone No: +61 2 4728 8090
Fax No: +61 2 4728 8040
Email: service@infa.com.au



Australian Standard

AS/NZS: 1754:2013
Licence No. 25324-1
SAI Global

ISSUE: D